

## B. — LITOBORINI

*Litoborinæ* ANTOINE, 1941, p. 19.

*Litoborini* ESPAÑOL, 1945, pp. 219, 225, 226. — KOCH, 1948, p. 403. — KOCH, 1953 *a*, pp. 270, 272.

Pandarites + Eurynotaires, p.p., MULSANT & REY, 1853 *b*.

Platynotides + Pédinides, p.p., LACORDAIRE, 1859.

*Phylacina*, p.p., REITTER, 1904, p. 107.

*Pedinini* + *Opatrini*, p.p., GEBIEN, 1938-1942.

Definition. — Body apterous, exceptionally alate (*Silvestriellum*, fig. 220). Epistome more or less strongly emarginate. Eyes constricted by genal canthus to completely divided into a dorsal and a ventral section. Gula non-stridulatory. Mentum uni-partite, in the genera from South of the Sahara with deeply emarginate apical margin, rounded sides and sometimes more or less distinctly marked median carinula basally (fig. 177). Maxillary palpi with sometimes extremely enlarged basal segment; the apical segment non-dimorphic, from triangular to moderately securiform (figs. 187, 188, 220, 223). Antennæ with eleven, exceptionnally ten (*Zoutpansbergia*, fig. 233) segments. Pronotum transverse to square, very variable in shape and lateral structures, exceptionnally with median carinæ on disc (*Tragardhus* s.str., fig. 229). Prosternal apophysis narrow, produced or with depressed apex. Elytra with nine or ten primary rows, of which one or two are situated on the ventrally reflected portion (figs. 178, 179); secondary intervals often, in the genera from South of the Sahara usually, with carinate costæ which sometimes are resolved into tubercles. Pseudopleura occurring in three formations; either complete, then narrow on posterior two-thirds and abruptly dilated and bent dorsad basally, reaching from base to the extreme apex of elytra and there being separated from the epipleural carina; or abbreviate apically, then shaped as in the preceding case, but not reaching the extreme apex of elytra, which is delimited by the epipleural carina alone; or absent on anterior half to two-thirds, but broad and well marked on apical third, there with the pseudopleural crest being well separated from the epipleural carina also on extreme apex (as is the case with the first mentioned formation). Pseudopleural crest not exposed dorsally. Metasternum usually short and much shorter than basal sternite of abdomen, exceptionnally about as long as the latter (*Silvestriellum*). Intercoxal process of basal sternite broad, slightly rounded to truncate. Anal sternite either marginate or entirely immarginate, rarely with obsolescent margination (in a few palæarctic species). Legs slender; the tibiæ narrow, only weakly dilated towards apex in all the genera from South of the Sahara, sometimes very strongly dilated and with apical, often also median tooth, in the palæarctic genera; the upper surface of intermediate and posterior tibiæ sometimes sulcate. Tarsi with distinct

5-5-4 scheme, in the ♂ the anterior tarsi often dilated. In this sex sometimes also the tibiæ and femora with moderately developed distinctive characters. (As in all the *Opatrinæ* the mesocoxal cavities with trochantin and the two preapical segments of abdomen with inter-segmental membrane). Ædeagal tegmen uni-partite, without separation between the apical and basal portions; inner sclerites composed of the penis plus a pair of lacinia. Length of body varying from 3 to about 15 mm.

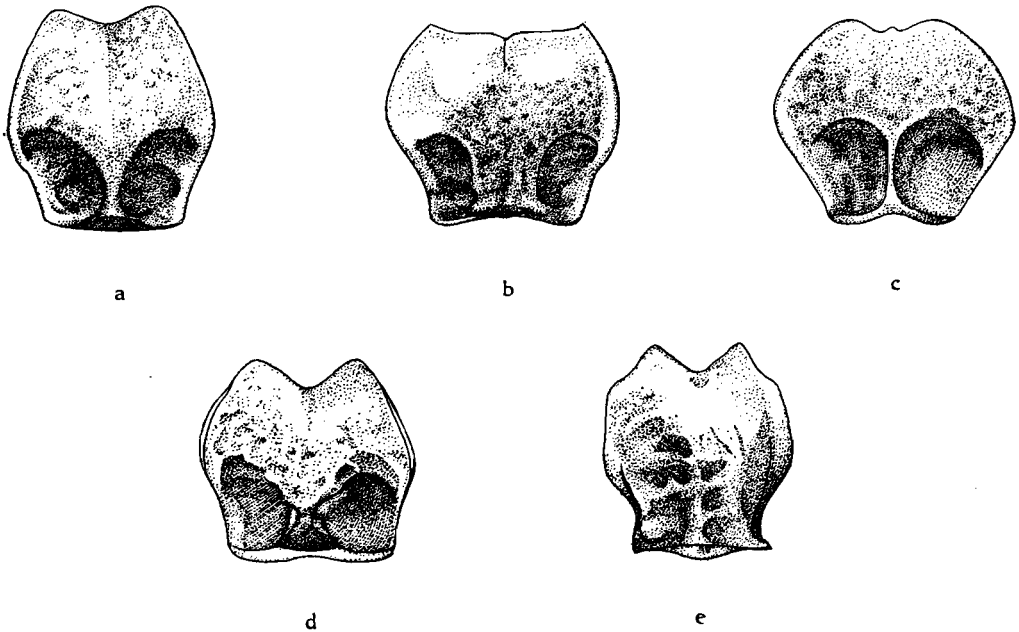

FIG. 177. — The mentum in a few *Zadenina* of *Litoborini*.

a: *Zadenos* (*Euzadenos*) *costifer* n. sp.; b: *Zadenos* (s. str.) *longipalpus* (WIEDEMANN);  
 c: *Zadenos* (*Serridenos*) *solenopistoma* n. sp.; d: *Minorus* *rugicollis* (MULSANT & REY);  
 e: *Hanstræmium* *adelostomoide* KOCH.

Relationship. — Within the *Opatrinæ* a quite isolated tribus which shows somewhat related only to the *Loensini* and *Leichenini* because of the uni-partite ædeagal tegmen. In habitus extremely variable, sometimes closely resembling other tribes of *Opatrinæ* and in one case (*Hanstræmium*, fig. 224) imitating to a striking extent the *Adelostomina* of *Eurychorini* (which belong to the subfamily of *Tentyriinæ*). Very peculiar and unique characters can be observed in the *Litoborini* from South of the Sahara, as there are the only ten-segmented antennæ in *Zoutpansbergia*, the alveolate gland on the dilated apical portion of pseudopleura in *Tragardhus* s. str., the development of wings in *Silvestriellum*, the long metasternum but

wingless body of the scaly *Gridelliopus*, and in particular the presence of supra-orbital carinæ, the *Adelostoma*-like apical segment of antennæ and the extremely enlarged basal segment of maxillary palpi in *Hanstræmium* (fig. 223).

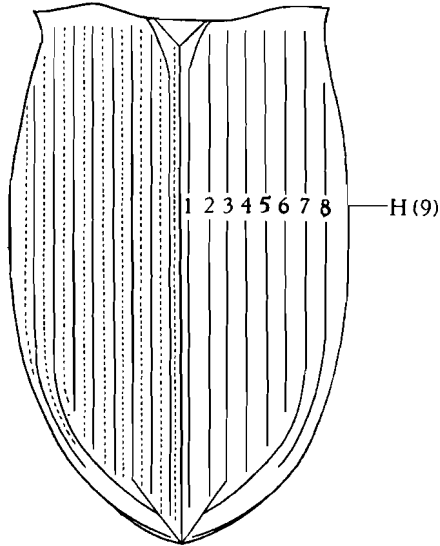

FIG. 178. — Scheme of the arrangement of sculpture on dorsal surface of elytra in the *Zadenina* of *Litoborini*.

Dotted lines : primary rows of punctures; continuous lines : the costate secondary intervals 1 to 9; 9 = H (humeral costa).

**Distribution.** — Originally believed to be endemic to the western and central parts of Northern Africa, the *Litoborini* have a disjunct Pan African distribution with evolution centres in the north-western part of Northern Africa and in the south-western part of Southern Africa, but occurring with isolated genera also in between these two centres in Tropical Africa (map 2). These isolated tropical genera are: *Hæmodus* and *Zoutpansbergia* from Southern Rhodesia and Northern Transvaal (map 5), *Hanstræmium* from the north-western part of Damaraland, Angola and the Southern Belgian Congo (map 5), while *Silvestriellum* and *Gridelliopus* are East African.

### DIVISION OF LITOBORINI.

ESPAÑOL, 1945, p. 226, has subdivided the palæarctic *Litoborini* into the two subtribes of *Litoborina* (ædeagus, figs. 180, 181) and *Melambiina* (ædeagi, figs. 182-186).

The *Litoborini* from South of the Sahara are extremely heterogeneous in their morphology and structure of ædeagus, particularly so with regard to the isolated tropical genera. Their intra-tribal division is of an extreme

sharpness and based on much more spectacular particulars than those used by ESPAÑOL for the two palæarctic subtribes. However, how greatly developed their differentiation also may be, they agree all in the immarginate anal sternite of abdomen (with the only exception of the alate *Silvestriellum*), by this particular being readily distinguished from all the palæarctic genera. In recognizing the super-ordinate importance of this character I am preferring to consider all the *Litoborini* from South of the Sahara an inseparable subtribe.

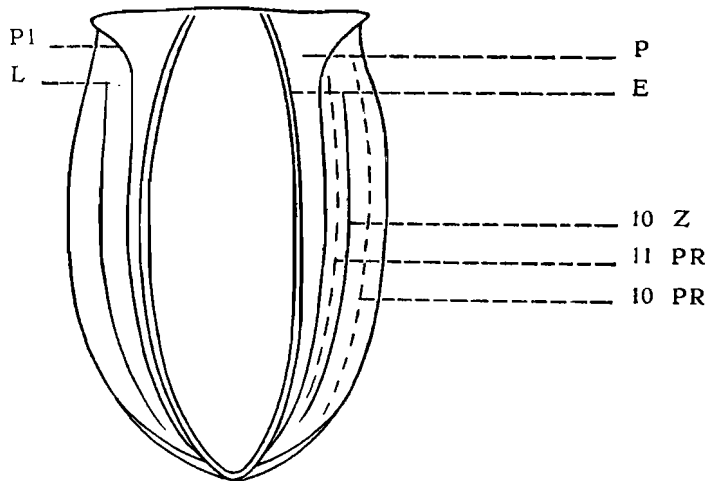

FIG. 179. — The ventrally reflected portion of elytra in *Zadenos*.  
E: epipleura; L: lateral interval; P: pseudo-pleura; P1: pseudo-pleural crest; 10 PR: tenth primary row; 11 PR: eleventh primary row; 10 Z: costa on tenth secondary interval.

1. Anal sternite of abdomen marginate (with a few exceptions, see key below). Eyes always divided by genal canthus into a dorsal and a ventral section. Apex of apical portion of ædeagal tegmen truncate, without parameral division (figs. 180, 181), or attenuate and with the parameres divided at least apically (figs. 182-186), when the anterior tibiæ are strongly dilated towards apex. Body apterous.  
Palæarctic *Litoborini* ..... 2
- Anal sternite of abdomen immarginate, with a single exception (*Silvestriellum*) but in this case the body alate. Eyes rarely divided by genal canthus. Apex of apical portion of ædeagal tegmen always attenuate (fig. 201); the parameres deeply divided, more or less gaping apically, sometimes spiniform and widely separated (fig. 225). Anterior tibiæ never strongly dilated.

#### ZADENINA.

Southern African and Tropical *Litoborini*.

2. Apex of ædeagal tegmen truncate; without parameral division (figs. 180, 181). Anterior tibiæ slender, very weakly dilated towards apex.

LITOBORINA.

- Apex of ædeagal tegmen attenuate; with parameral division at least apically (figs. 182-186). Anterior tibiæ strongly dilated towards apex.

MELAMBIINA.

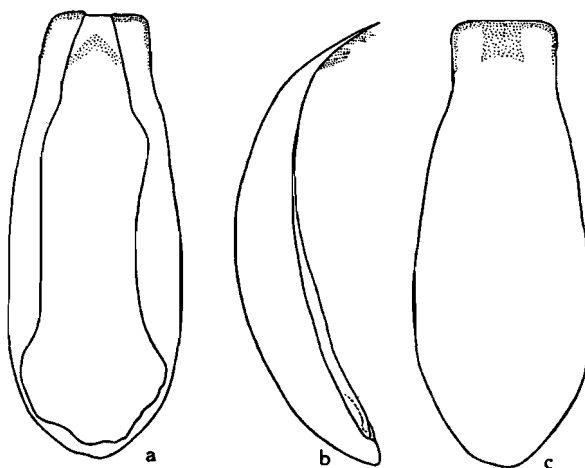

FIG. 180. — The dissected and emptied ædeagal tegmen of *Litoborus* spec. from « Algeria ».

a : ventral surface; b : lateral aspect, with the ventral surface at right; c : dorsal surface.

KEY TO ALL GENERA,  
BUT SPECIES ONLY FROM SOUTH OF THE SAHARA.

1. Anal sternite of abdomen immarginate, except for *Silvestriellum*, when the body is alate and the elytra densely covered with erect bristles. Eyes more or less strongly emarginated by genal canthus, sometimes completely divided, but in these cases the ventrally reflected portion of elytra with two primary rows of primary punctures.

(Tropical and Southern African genera and species.)

**Zadenina** ..... 2

- Anal sternite of abdomen marginate. The only exceptions with immarginate or incompletely marginate anal sternite are the ♀ of *Melasmiana*

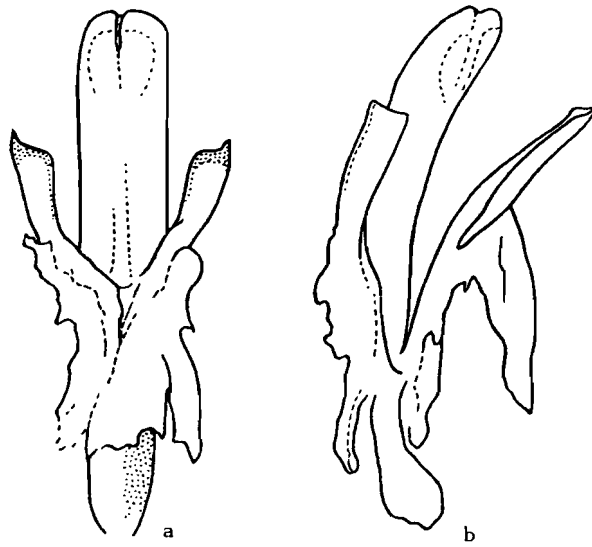

FIG. 181. — The extracted penis with lacinia of *Litoborus* spec.  
from « Algeria ».

a : outer surface; b : diagonal view.

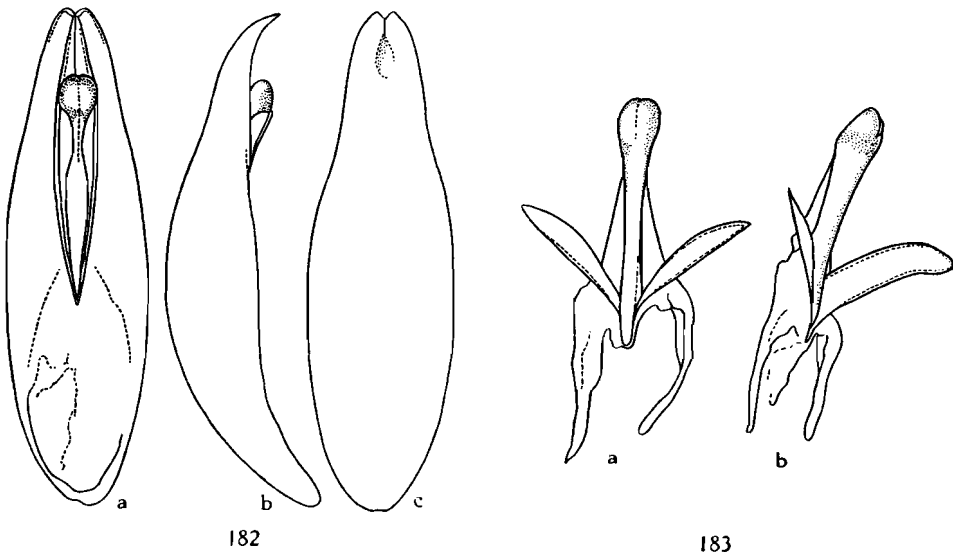

FIG. 182. — Aedeagus of *Hoplarion* (s. str.) *attritum* BEDEL (a : ventral surface; b : lateral aspect, with the ventral surface at right; c : dorsal aspect). — FIG. 183. — The extracted penis plus lacinia of *Hoplarion* (s. str.) *attritum* BEDEL.

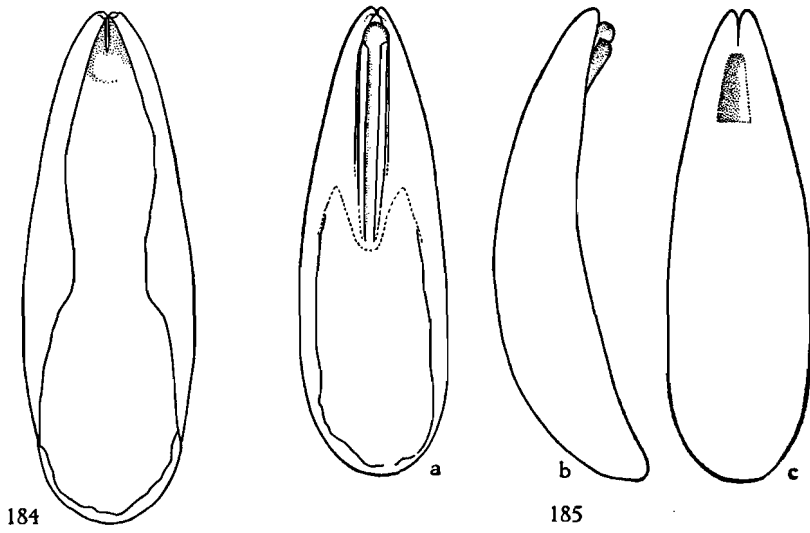

FIG. 184. — The dissected and emptied aedeagal tegmen of *Hoplarion* (s. str.) *attritum* BEDEL. — FIG. 185. — Aedeagus of *Hoplarion* (*Saharoplarion*) *compactum* (FAIRMAIRE) (a: ventral surface; b: lateral aspect, with the ventral surface at right; c: dorsal surface).

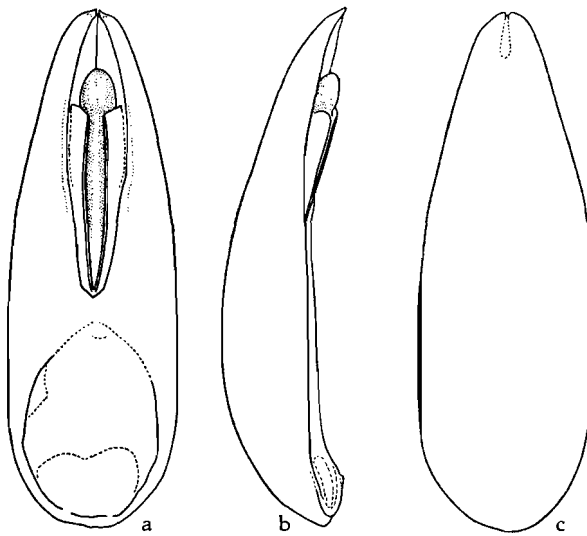

FIG. 186. — Aedeagus of *Hoplariobius* (*Glyptariobius*) *excavatus* KOCH. a: ventral surface; b: lateral view, with the ventral surface at right; c: dorsal surface.

(*Heliomelasma*) *appenhageni* KOCH, *Allophylax* (s. str.) *picipes* OLIVIER with subspecies, and *Allophylax* (*Litoboromimus*) *parallelus* SCHUSTER. In these species, however, the eyes are completely divided by the genal canthus, whereas the ventrally reflected portion of elytra exhibits at the best a single primary row of punctures. Body apterous, the upper surface of elytra practically bare, without erect bristles, sometimes the sides ciliate.

[Palæarctic genera and subgenera (cf. KOCH, 1948, p. 405)] ..... 71

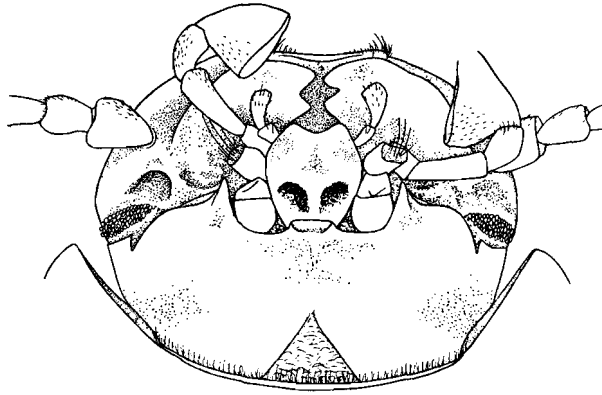

FIG. 187. — Under surface of head of *Zadenos* (*Serridenos*) *solenopistoma* n. sp.

(SUBSAHARAN *LITOBORINI*.)

2. Pseudopleural carina of elytra complete or abbreviated apically, but always clearly developed from base to the apical portion ..... 3
- Pseudopleural carina of elytra developed only apically around distal sternites of abdomen, but absent from base to apical portion ..... 59
3. Upper surface of body bare or with inconspicuous, microscopically short bristles; in a few cases the adherent bristles well perceptible, but very fine [*Zadenos* (*Euzadenos*) *incostatus*, *Minorus pilosicollis*, *Lasioderus sulcipennis*, etc.] ..... 4
- Upper surface of body either with erect bristles, at least on costal elements of elytral sculpture, or entirely covered with dense, elongate and semi-sessile scales ..... 56
4. Elytra with ten primary rows, of which two are situated on the ventrally reflected portion; the latter considerably broader than pseudopleura ..... 5



- Elytra with only nine primary rows; the ventrally reflected portion narrow, not or scarcely broader than pseudopleura, with only a single primary row ..... 51
5. Anterior tarsi distinctly dilated in the ♂, except for the subgenus *Serridenos*, when the mandibular ridge of postgenal margin is produced into a dentiform lobe. Ventrally reflected portion of elytra plane, with the exception of two species with fine costula between the ninth and tenth primary rows, but then either the upper surface of intermediate and posterior tibiæ sulcate [*Zadenos* (s. str.) *longipalpus*], or the sides of pronotum sinuate in front of posterior angles [*Zadenos* (*Euzadenos*) *lightfooti* and *gnophotoides*], or the outer contours of elytra appearing

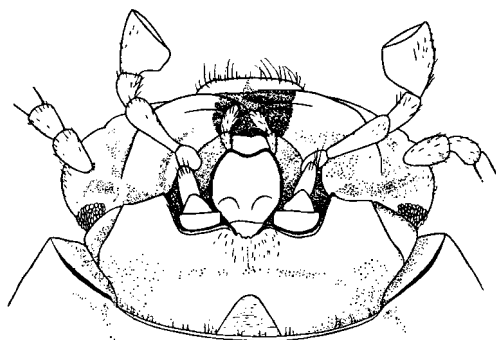

FIG. 188. — Under surface of head of *Minorus sculpticeps* n. sp.

as if denticulate [*Zadenos* (*Serridenos*) *XX-costatus*]. Pseudopleura abbreviated apically. Genal canthus strongly constricting eyes but not dividing the latter. Pronotum of variable shape, but the sides subparallel posteriorly or dilated towards base only, when the pronotum is more or less distinctly shiny.

**ZADENOS** LAPORTE DE CASTELNAU ..... 6

(Fig. 187.)

\*1840, *Zadenos* LAPORTE DE CASTELNAU, p. 210. — 1854 a, MULSANT & REY, p. 177. — 1854 b, MULSANT & REY, p. 33. — 1953 a, KOCH, pp. 270, 272.

Head (fig. 187) with large and prominent genæ. Eyes not divided but strongly constricted by genal canthus. Mentum sometimes with short median carinula basally. Apical segment of maxillary palpi about as broad as long; basal segment short. Postgenæ simple; the mandibular ridge of postgenal margin sometimes more or less strongly produced, from angular to dentiform. Antennæ with eleven segments. Pronotum transverse, with well separated to very densely

rugose sculpture; sides of variable shape, posteriorly subparallel, slightly dilated, rounded and narrowed to sinuate in front of posterior angles; submarginal depression from absent to very strong and broad. Prosternal apophysis horizontally produced, but often with the apex of produced portion depressed. Elytra more or less closely attached to pronotum, but often also widely separated from the latter, not to considerably broader than pronotum, with obtuse to dentiform prominent humeral angle, bare or with very fine and adherent bristles. With ten primary rows, of which two are situated on the ventrally reflected portion of elytra; secondary intervals punctured to subgranulate, in various ways costate at least on sides, but sometimes with the costæ resolved into separated and elongate tubercles, sometimes the costæ strongly serrate or denticulate, in a single case without any costæ [*Zadenos (Euzadenos) incostatus*]. Pseudopleura abbreviated apically, the apex of elytra therefore formed by the sharp and thin epipleural carina alone; considerably narrower than the ventrally reflected portion of elytra. Metasternum short. Anal sternite immarginate. Upper surface of intermediate and posterior tibiæ sometimes sulcate; in the ♂ the anterior tarsi usually distinctly dilated, except for the subgenus *Serridenos*; sometimes the tibiæ and femora with distinctive characters. Ædeagus with converging and well divided parameres; the inner sclerites simple, with the exception of the subgenus *Serridenos*, in which the penis is inserted on a peculiar and roundish sclerite.

Dimensions. — 4 ½ to 13 ½ mm long.

Type species. — *Opatrum longipalpe* WIEDEMANN, 1823.

Composition. — Of the few previously described species only the following belong to *Zadenos*: *Opatrum longipalpe* WIEDEMANN and *acutum* WIEDEMANN, *Pedinus ruficornis* GERMAR, *Eurynotus (Solenopistoma) acutus* MULSANT & REY, *Eurynotus (Zadenos) bohemani* MULSANT & REY, *capriciosus* MULSANT & REY and *delalandei* MULSANT & REY (of which *Eurynotus tenuecostatus* FAIRMAIRE is a synonym), as well as *Oncotus bistratus* FAIRMAIRE.

The *Zadenos* can be sharply divided into the three subgenera *Zadenos* s. str., *Euzadenos* and *Serridenos*.

Distribution (map 5). — Southern African, in moderate distance from the coast, extending from the southern part of the South-western Cape Province, the Cape Peninsula included, to the southern part of Portuguese East Africa and the Northern Transvaal, in the East, however, spreading far more (Zoutpansberg) than in the West.

- Anterior tarsi non-dimorphic, not dilated in the ♂. Ventrally reflected portion of elytra with fine costa on tenth secondary interval, with the

exception of the following four species, in which this costa is absent, but in these cases either the pseudopleura complete and extending to extreme apex of elytra (*Minorus XVIII-seriatus*), or the sides of pronotum subparallel or dilated posteriorly, but the integument of pronotum dull (*Minorus thornei*, *pilicollis* and *barnardi*). Sides of pronotum never sinuate in front of posterior angles. Upper surface of posterior and intermediate tibiæ not sulcate. Genal canthus often completely dividing the eyes.

**MINORUS** MULSANT & REY ..... 38

(Fig. 188.)

\*1854 a, *Minorus* MULSANT & REY, p. 185. — 1854 b, MULSANT & REY, p. 41. — 1953 a, KOCH, pp. 271, 272.

This genus is very closely related to *Zadenos* and, although exhibiting a quite different habitus in the species of the typical group (*rugicollis* group), there exist several intermediate species with regard to the otherwise very conspicuous characters of the complete pseudopleura of elytra, the completely divided eyes and the often very peculiar sculpture of upper surface. Nevertheless I have preferred to maintain this genus, basing it, with the intermediate species included, on the non-dimorphic anterior tarsi in the ♂ and the dull upper surface of body.

In *Minorus* all secondary intervals on elytra are finely carinate, with the crest of costæ sometimes serrate-denticulate. With the exception of the complete pseudopleura of elytra and the completely divided eyes in some of the species, in the remainder of characters agreeing with *Zadenos*. Underside of head fig. 188.

Dimensions. — 5 ¼ to 10 ¼ mm long.

Type species. — *Eurynotus (Minorus) rugicollis* MULSANT & REY, 1854.

Composition. — Of the many species of this genus only the type species was known previously.

Distribution (map 5). — Southern African, confined to the Western and Central-southern Cape Province, in the South-west overlapping the range of *Zadenos*. Extending from the Orange River southwards to the South-western and South-central Cape Province as far eastwards as the Steytlerville and Aberdeen Districts.

6. Upper surface of intermediate and posterior tibiæ evenly convex or flattened, but not sulcate.

- ZADENOS** subg. **EUZADENOS** nov. .... 7
- Type species : *Eurynotus (Zadenos) delalandei* MULSANT & REY.
- Upper surface of intermediate and posterior tibiæ sulcate ..... 36
7. Disc of pronotum with separated, round to slightly confluent punctation, with the intervals between punctures plane and not rugosely raised ... 8
- Disc of pronotum with extremely dense, rugosely confluent to subgranular or substriolated sculpture; the intervals between punctures forming raised rugosities ..... 20
8. Body of larger size, 7 to 10 ½ mm long ..... 9
- Body of smaller size, 4 ½ to 6 ¼ mm long ..... 16
9. Sides of pronotum subparallel or distinctly dilated on posterior third. 10
- Sides of pronotum from slightly to strongly rounded and narrowed on posterior third, sometimes sinuate in front of posterior angles ..... 12
10. Apical declivity of elytra with the third interval sharply costate, angularly bent towards the costate suture in front of apex and coalescent with sutural costa apically. Pronotum with dense punctation, becoming slightly confluent on lateral portions ..... 11
- Apical declivity of elytra with the sutural costa evanescent and the costa of third interval straight and abruptly ending at short distance from apex. Pronotum with rather scattered punctation, well separated and round also on lateral portions.

[**Zadenos (Euzadenos) algoensis** n. sp.]

(Pl. XXV, fig. 1.)

Very closely related to *Z. delalandei* and agreeing with the latter in the elytral sculpture. Differing by the smoothed and strongly shiny cuticle, the smaller and more slender body, the reddish brown legs, slightly more elongate antennæ, less convex eyes, finer and round punctures on head, and in the ♂ by the straight inner contours of anterior and intermediate tibiæ, as well as by the reduced pilosity on underside of tibiæ and posterior femora. The ædeagus is very similar, but smaller, with the parameres shorter, less strongly divided apically and not demarcated from the basal portion of ædeagus; the outlines of the latter (in dorsal view) are continuous with those of parameres and gradually narrowed towards apex.

Dimensions. — Length 7 ¼ - 7 ½ mm; width 3 ½ mm.

Distribution. — Central part of the Southern Cape Province. — Algoa Bay, H. BRAUNS (1♂, 2♀, types T.M.).

11. Body more slender, 3 to 5 mm broad. Pronotum without or with narrow submarginal depression on sides; base only a little narrower than elytral base. Base of elytra with the costa on seventh interval transversely prolonged, curved towards humeral angle and united with the latter, but the costa on eighth interval abbreviate, not reaching the base.

[**Zadenos (Euzadenos) delalandei** (MULSANT & REY).]

(Pl. XXV, fig. 2.)

\*1854 a, *Eurynotus (Zadenos) delalandii* MULSANT & REY, p. 182. — 1854 b, MULSANT & REY, p. 38.

1870, *Eurynotus delalandi* GEMMINGER & DE HAROLD, p. 1914.

1910 b, *Eurynotus delalandei* GEBIEN, p. 276. — 1933-1942, GEBIEN, p. 414, n° 5544.

1897, *Eurynotus tenuecostatus* FAIRMAIRE, p. 117 (= syn. nov.).

Original description. — « Long. 8,7 to 9 mm, larg. 4,2 to 4,5 mm — Corps ovale oblong; faiblement convexe; noir ou d'un noir brun mat ou peu luisant. Tête ponctuée, plus grossièrement sur le front; déprimée ou largement sillonnée sur la suture frontale. Antennes noires ou brunes à la base, graduellement d'un rouge ou brunâtre à l'extrémité, quelquefois d'un brun rouge passant graduellement au rouge brun à l'extrémité; prolongées environ jusqu'aux quatre-cinquièmes des côtés du prothorax; grossissant sensiblement à partir du septième article: le troisième de moitié ou des deux-tiers plus long que le cinquième: les sixième à huitième obconiques: les neuvième et dixième plus larges que longs: le onzième presque orbiculaire, au moins aussi large et de moitié plus long que le précédent. Prothorax élargi d'avant en arrière, en ligne à peu près droite postérieurement; muni latéralement d'un rebord peu épais, égal, médiocrement saillant; assez faiblement bisinué à la base, avec le tiers médiaire de celle-ci en ligne droite, et les angles sensiblement plus prolongés en arrière; muni d'un rebord basilaire non interrompu; assez faiblement convexe; légèrement inégal; offrant souvent sur son tiers postérieur les traces plus ou moins marquées d'un sillon longitudinal médiaire, marqué de points assez fins et rapprochés non réticuleux; offrant vers les angles postérieurs sa plus grande largeur; sans gouttière près de ses bords. Ecusson petit; presque en demi-cercle. Elytres aussi larges ou à peine plus larges en devant que le prothorax à ses angles postérieurs; munies d'une petite dent à l'angle huméral; un peu obliquement coupées sur les deux-cinquièmes externes de leur base; faiblement élargies jusqu'aux deux-cinquièmes, en ogive obtuse à l'extrémité; faiblement ou assez faiblement convexes: à dix sillons (huit seulement visibles en dessus): les deux ou trois premiers ordinairement affaiblis en devant et parfois presque réduits à des stries: ces sillons marqués dans leur milieu d'une rangée longitudinale de points

petits et souvent peu distincts, pointillés sur les côtés. Intervalles en forme de toit : les deux premiers plus ou moins affaiblis en devant : les autres en arête lisse et assez vive sur leur tranche : le huitième dirigé vers l'angle postérieur du prothorax : le septième, aboutissant par conséquent en devant à un point de la base situé en dedans de l'angle précité, lié à l'angle huméral par une ligne élevée transverse plus ou moins marquée : le septième intervalle lié postérieurement au troisième, et prolongé avec lui jusqu'à l'angle sutural, enclosant ainsi les quatrième à sixième : le cinquième, plus long que ses deux voisins : les neuvième et dixième intervalles, visibles seulement en dessous, plans, ponctués ainsi que le repli. Dessous du corps ponctué sur les côtés de l'antépectus. Ventre plus finement ou moins grossièrement ponctué. Prosternum rebordé, relevé à son extrémité. Tibias antérieurs presque cylindriques. ♂ Trois premiers articles des tarsi antérieurs garnis en dessous d'une brosse serrée ou de sortes de ventouses : les deuxième et troisième, dilatés. ♀ Tarsi non garnis de ventouses et peu ou point dilatés.»

Remarks. — Genæ subparallel, their outlines almost in line with those of eyes. Prosternal apophysis horizontally produced beyond coxal cavities. Humeral angle of elytra practically rectangular, but not or scarcely prominent; intervals densely punctured, with sharply raised costæ on outer dorsal intervals, becoming weaker and obtuse towards suture; sutural interval faintly convex discally, becoming costate on apical declivity. In the ♂ the second and third segments of anterior tarsi strongly transverse; the underside of anterior tibiæ excavate on middle, the inner contours of tibiæ therefore not straight, but very faintly dilated in front of middle and very shallowly emarginated between middle and apex; intermediate tibiæ with the inner contours strongly dilating on proximal two-thirds and subparallel on distal third, there with a subtomentose stripe of yellowish hairs on underside; posterior tibiæ straight, with a longitudinal stripe of yellowish, short, slightly squarrose hairs on underside; posterior femora with a brush of fine yellowish hairs on proximal two-thirds.

Ædeagus. — Basale demarcated from apicale by a transverse impression dorsally. Apicale gradually narrowed from base to about middle, thence almost subparallel, with the parameres long, completely and deeply divided on dorsal surface, gaping apically and exhibiting obtuse apices. Ventral surface with broad open groove, leaving exposed the pointed apex of penis and the apical portion of lacinia; the latter broadly rounded and bent outwards.

Dimensions. — Length  $7\frac{3}{4}$  to 9 mm, width 3 to 5 mm.

Synonymy. — The description of *Eurynotus tenuecostatus* FAIRMAIRE agrees completely with *delalandei* and can not be referred to any of the other related species.

Type locality. — «L'Afrique méridionale», type probably in Museum Paris.

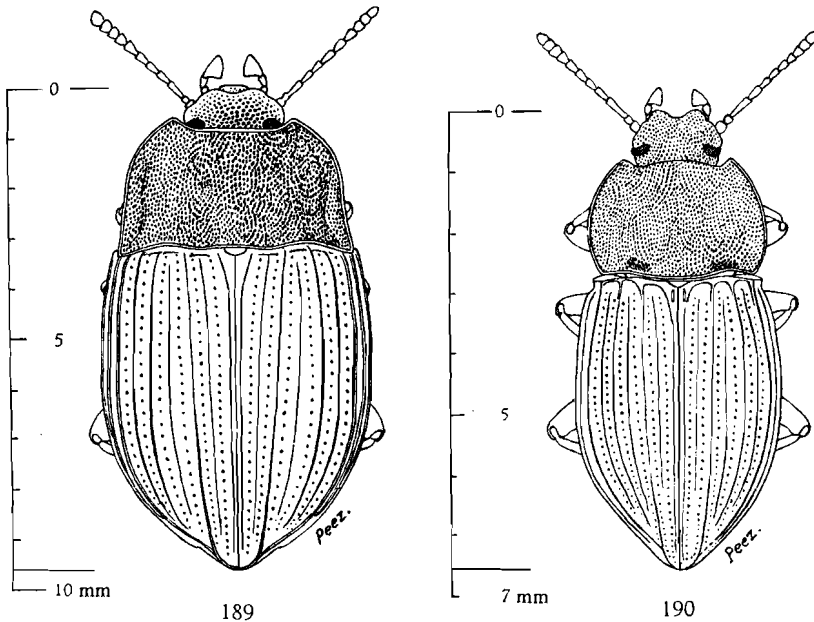

FIG. 189. — *Zadenos (Euzadenos) capriciosus* (MULSANT & REY).

FIG. 190. — *Zadenos (Euzadenos) rotundicollis rotundicollis* n. sp.

Distribution. — Central part of the Southern Cape Province. — Port Elizabeth (type locality of *tenuecostatus*) (T.M., S.A.M.); Uitenhage (S.A.M.); Somerset East (S.A.M.); Addo Bush (S.A.M.); Grahamstown (T.M., Rh.U., S.A.M.); Resolution near Fort Brown (T.M.); Van Stadens River (S.A.M.); Hogsback, Amatola Mts. (S.A.M.); Keurbooms River, Knysna District (S.A.M.); Mossel Bay (B.M., U.L.).

- Body broad, with the greatest width varying from  $4 \frac{1}{4}$  to  $5 \frac{1}{2}$  mm. Pronotum with broad, densely punctured, strong, submarginal depression of sides; base conspicuously narrower than elytral base. Base of elytra with the costa on seventh interval transversely united with the prolonged costa of eighth interval, but not continuing to, and not in contact with, the humeral angle.

[**Zadenos (Euzadenos) capriciosus** (MULSANT & REY).]

(Pl. XXV, fig 3; Figs. 189, 191.)

\*1854 a, *Eurynotus (Zadenos) capriciosus* MULSANT & REY, p. 184. — 1854 b, MULSANT & REY, p. 40.  
1870, *Eurynotus capriciosus* GEMMINGER & DE HAROLD, p. 1914. — 1910 b, GEBIEN, p. 275.

Original description. — « Dans la collection du Muséum de Paris se trouvait, avec l'exemplaire que nous venons de décrire (*Z. delalandei*), un autre individu paraissant constituer une espèce particulière (*E. capriciosus*). Ce dernier s'éloigne du précédent, par son corps plus ovalaire, moins parallèle sur la moitié médiale de sa longueur; par ses élytres non munies d'une dent à l'angle huméral; par le septième intervalle non lié au dit angle, vers la base, par une petite ligne ou arête transverse; mais cet insecte trouvé également par M. DELALANDE, et probablement dans les mêmes lieux que l'*E. delalandei*, a d'ailleurs tant de ressemblance avec celui-ci, que les différences que nous venons de signaler ne sont peut-être qu'une variation de l'espèce. »

Remarks. — *Z. capriciosus* is not a variation of *delalandei* but a good species which differs constantly from *delalandei* by the larger and more oval body, much denser punctation on pronotum, the slightly obtuse and not prominent humeral angles of elytra, as well as by the above mentioned characters. Both species agree well in the elytral sculpture, formation of legs in the ♂ and the structure of aedeagus. The latter is a little broader than in *delalandei*, with stouter parameres of aedeagus. Intermediate tibia of ♂ fig. 191. *Z. capriciosus* has been omitted by GEBIEN, 1938-1942.

Dimensions. — Length 8  $\frac{1}{4}$  to 10  $\frac{1}{2}$  mm, width 4  $\frac{1}{4}$  to 5  $\frac{1}{2}$  mm.

Type locality. — MULSANT & REY supposed correctly the same patria as that of their *E. delalandei* (« L'Afrique méridionale »). Type probably in Museum Paris.

Distribution. — Central part of the Southern Cape Province. — Algoa Bay (T.M.); Port Elizabeth (T.M., S.A.M.).

Habitat. — It is probable that the habitat of this species may be different from that of *delalandei*, although both species, together with *algoensis*, have been recorded from identical localities. However, all the specimens examined of *capriciosus* have been collected at « Algoa Bay » by H. BRAUNS (together with *algoensis*) and at « Port Elizabeth » by H. BRAUNS, C. G. C. DICKSON and A. MOORHOUSE, whereas *delalandei* has not been recorded from « Algoa Bay » and the many specimens from « Port Elizabeth » have been collected but by different collectors, viz. myself, P. BRINCK and R. F. LAWRENCE.



12. Sides of pronotum not sinuate in front of posterior angles. Intervals on elytra from more or less convex to sharply and continuously costate ..... 13
- Sides of pronotum strongly sinuate in front of posterior angles. The six inner intervals on elytra with numerous elongate tubercles.

[**Zadenos (Euzadenos) natalensis** n. sp.]

(Pl. XXV, fig. 4.)

Owing to the cordiform pronotum and tuberculate elytra resembling *Hadroderus tuberculiferus*.

Black, the appendages of a dark reddish brown tint. Head densely punctured, shiny, shaped as in *delalandei*, but less strongly enclosed in prothorax. Antennæ rather stout, strongly accrescent, with transverse two preapical segments, and the apical segment large, subtruncate apically, scarcely narrower than the preceding segment, but about one and a half times as long as the latter. Pronotum moderately shiny, broadest at about middle, transverse, two-thirds broader than long, moderately convex on disc, broadly depressed along sides, with rather coarse, dense, but round punctation, sparsely and briefly pilose, with rather strongly rounded, posteriorly sinuate sides and bi-sinuate, obsolete carinate base. Prosternal apophysis horizontal. Elytra sericeous, convex, considerably broader than pronotum, rounded and narrowed towards base, with the latter being much broader than pronotal base. Primary rows with fine, shallow and scattered punctures. Intervals without distinct punctation; the six inner intervals each with a longitudinal row of fine, elongate and shiny tubercles, becoming more numerous towards sides and on third interval apically; the three outer intervals sharply costate, but the crest of costæ somewhat crenulate, becoming evanescent at considerable distance from apex of elytra. Reflected lateral portion, plus pseudopleura, very opaque, impunctate, except for the two coarsely punctured primary rows. Abdomen with short, yellowish hairs, and dense, fine punctures, scattered on third and fourth sternites. Legs pilose, similar to *delalandei*. ♂ unknown.

Dimensions. — Length  $8 \frac{3}{4}$  to  $9 \frac{1}{4}$  mm, width  $4 \frac{1}{4}$  to  $4 \frac{3}{4}$  mm.

Distribution. — Natal. — Umhlanga, IV.1941 (1♀, holotype M.S.Rh); Amanzimtoti, VII.1907 (1♀, paratype D.M.).

13. Sides of pronotum narrowed faintly and in an almost straight line towards base; pronotum moderately shiny, with narrow submarginal depression of sides and distinctly produced, sharp, practically rectangular posterior angles ..... 14

- Sides of pronotum strongly rounded and narrowed towards base; pronotum very shiny, with broad, strong, subsulcate submarginal depression of sides and scarcely produced, obtuse posterior angles ..... 15
14. Pronotum uniformly covered with fine, dense, but separated, round punctures, from which arise microscopically short, yellowish bristles.

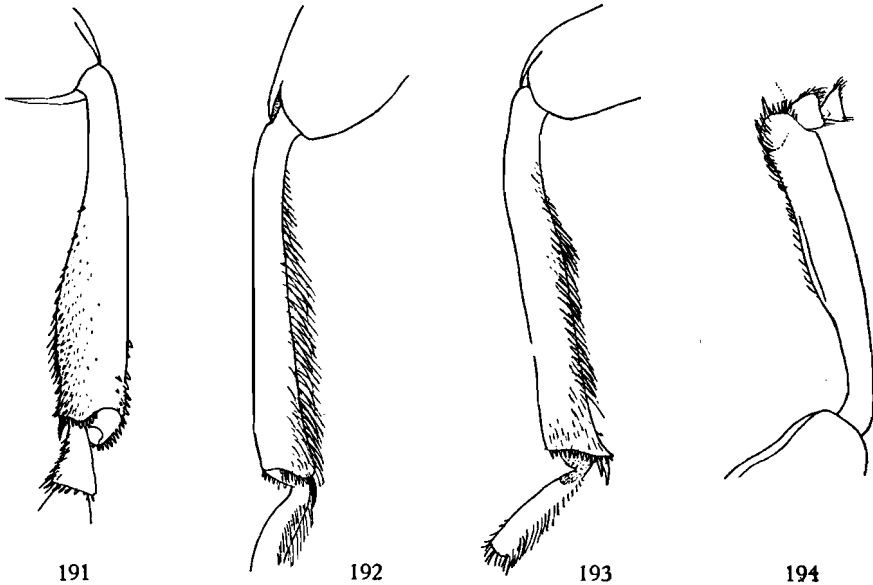

FIG. 191. — Intermediate tibia of a ♂ of *Zadenos (Euzadenos) capriciosus* (MULSANT & REX). — FIG. 192. — Posterior tibia of a ♂ of *Zadenos (Euzadenos) rotundicollis rotundicollis* n. sp. — FIG. 193. — Posterior tibia of a ♂ of *Zadenos (Euzadenos) monticola monticola* n. sp. — FIG. 194. — Anterior tibia of a ♂ of *Zadenos (Euzadenos) externus* n. sp.

Intervals and pseudopleura of elytra sericeous, without discernible punctation; only the four outer intervals sharply and continuously costate, the inner intervals carinate at most basally and apically.

[***Zadenos (Euzadenos) zuluanus*** n. sp.]

Related to *delalandei*, but more slender and with almost dull upper surface. Head above coarsely and densely punctured; lateral portions of epistome strongly and angularly produced; clypeal sutures deeply impressed laterally. Pronotum broadest at about middle, a little less than one and a half times as broad as long; punctation slightly finer than on head, but less dense and uniform, bearing microscopically short, yellowish bristles; submarginal depression of

sides broadened towards base; the latter carinate and rather well bi-sinuate. Episternum of prosternum with coarse, sparse punctures, and a broad, smooth submarginal area along sides; intercoxal apophysis briefly produced, with short, tuberculiform apex. Elytra moderately broader than pronotum, with faintly rounded sides and minutely demarcated humeral angle. Primary rows with fine, but deep punctures. Intervals with extremely fine, scarcely discernible punctation; the costæ of seventh and ninth intervals transversely united basally; on apical declivity all intervals costate, except for the two inner ones, with the third costa indistinctly approximated to suture apically. Abdomen with fine, moderately dense punctation, more concentrated on anal sternite. Legs reddish brown, shaped as in *delalandei*. ♂ unknown.

Remarks. — *Z. zuluanus* shows also related to *natalensis* on account of the well separated, setiferous punctation on pronotum, and the sericeous elytra, the intervals of which are not distinctly punctured, but exhibit a few minute granules on posterior portion of inner intervals. Apart from the characters mentioned in the key, *zuluanus* is readily recognized from *natalensis* by the smaller, much more slender shape of body, the quite different elytral sculpture and the almost inconspicuous pilosity on pronotum and abdomen.

Dimensions. — Length  $7\frac{1}{2}$  mm, width  $3\frac{1}{4}$  mm.

Distribution. — Zululand. — Junction Mfolozi and Onkudu Rivers, VII.1905, I. TRÄGÅRDH (1♀, holotype M.St.).

- Pronotum bare, with very dense punctation, tending to become confluent on disc, rugose on sloping lateral portions inwards from submarginal depression. Intervals and pseudopleura of elytra moderately shiny, with fine, dense, but deep punctures; all intervals sharply and continuously costate, except for the sutural interval

[**Zadenos (Euzadenos) lawrencei** n. sp.]

(Pl. XXVI, fig. 1.)

Closely related to *Z. zuluanus*, but the pronotum narrower and with very narrow submarginal depression of sides, the elytra with coarsely punctured primary rows, the third costæ of both elytra sharply raised and together coalescent with sutural costa apically, and the costa of seventh interval coalescent with the third costa in front of apex of elytra. In the ♂ the second and third segments of anterior tarsi transverse; the anterior tibiæ excavate and pilose on underside, with the inner contours slightly dilated on distal half; the intermediate and posterior tibiæ straight, pilose on underside, but without tomentose stripes; the femora simple, without brush-like pilosity on underside.

**Ædeagus.** — Similar to *delalandei*, but differing by the broad, apically subtruncate penis and the parameres which are scarcely bent, short, strongly gaping apically, but distinctly divided only on apical third of length of ædeagus.

**Dimensions.** — Length 7-7  $\frac{1}{2}$  mm, width 3  $\frac{1}{4}$ -3  $\frac{3}{4}$  mm.

**Distribution.** — Natal. — Pietermaritzburg, XI.1940, R. F. LAWRENCE (4♂♂, 2♀♀, types S.A.M.).

**Dedication.** — Named in honour of Dr. R. F. LAWRENCE, former director of the Natal Museum, Pietermaritzburg.

15. The punctures of primary rows of elytra coarse, considerably coarser than discal punctures on pronotum. In the ♂ the inner contours of posterior tibiæ straight and provided with a fringe of dense, yellowish, squarrose hairs.

[**Zadenos (Euzadenos) rotundicollis** n. sp.]

(Pl. XXVI, fig. 2; Fig. 190.)

Black to reddish brown, the appendages from reddish brown to almost black. Head above with dense, coarse and partially confluent punctures; genæ subparallel; eyes convex, slightly projecting beyond contours of genæ. Antennæ long, accrescent, with elongate segments proximally; the preapical segments only slightly broader than long. Pronotum broadest slightly behind middle, about one and a half to one and two thirds times as broad as long, bare, strongly shiny, with strongly rounded and narrowed sides, moderately convex disc, and thick lateral carina. Punctuation fine, well separated on disc, there finer than punctures on head, becoming stronger, denser and sometimes slightly and longitudinally confluent towards sides, round and rather scattered on the broad submarginal depression. Base faintly bi-sinuate, with obtuse posterior angles. Prosternal apophysis depressed and subdenticulate. Elytra only slightly broader than pronotum, with weakly rounded sides, shiny, depressed. Intervals finely punctured, with at least the four outer intervals sharply costate; sutural interval not costate; on apical declivity both the third costæ rather obtuse, coalescent together with sutural interval apically and in contact with the seventh costa. Base appearing as if carinate, with the humeral angle forming a more or less distinct, prominent, minute tooth. Abdomen with fine, uniformly scattered punctures, becoming very dense and finer only on posterior portion of anal sternite. Legs as in the other *Zadenos*; in the ♂ the anterior tarsi dilated, with transverse second and third segments; all tibiæ straight, the underside of anterior tibiæ with a shallow median impression, bearing a few fine yellowish hairs, and the underside of posterior tibiæ (fig. 192) with hairy fringe; underside of posterior femora with fine brush of yellowish hairs.

**Ædeagus.** — Sides strongly, continuously rounded and narrowed towards apex; parameres gaping, strongly divided, with the apex sharply pointed, inclined inwards and strongly bent ventrad; penis obtuse apically.

**Dimensions.** — Length  $7\frac{1}{2}$ -8 mm, width  $3\frac{1}{4}$ - $3\frac{3}{4}$  mm.

**Subspecies:** —

*a) rotundicollis* s. str. — Body dark to reddish brown, with brownish, transparent lateral margin of pronotum; the legs constantly of a pale reddish brown to almost testaceous tint. Lateral punctation on pronotum only slightly tending to become confluent. Elytra less shiny, with sharply carinate base; primary rows with moderately dense punctures; apart from the sutural interval, all other inner intervals obtusely, but distinctly carinate also on disc.

**Distribution.** — Central part of the Southern Cape Province. — Willowmore, H. BRAUNS (1♂, 2♀♀, types T.M.).

*b) elizabethensis* n. subsp. — Body black; the legs blackish brown, with the exception of the reddish brown tarsi. Lateral punctation on pronotum distinctly and longitudinally confluent. Elytra strongly shiny, with obtusely carinate base; primary rows with very dense punctures; only the four outer intervals sharply costate, the inner ones on disc more or less convex, becoming flattened towards suture.

**Distribution.** — Central part of the Southern Cape Province. — Van Staaden's River, 20 m E of Port Elizabeth, II.1933, R. F. LAWRENCE (2♂♂, holotype S.A.M.).

- The punctures of primary rows of elytra fine, about as strong as the discal punctures on pronotum, or slightly finer. In the ♂ the inner contours of posterior tibiæ with a small, obtuse premedian dilation and a few fine squarrose hairs.

[**Zadenos (Euzadenos) monticola** n. sp.]

(Pl. XXVI, fig. 3; Fig. 193.)

Very closely related to *Z. rotundicollis*, but of larger size, shiny, black, the legs blackish to dark reddish brown, the pronotum with very broad, sulcate submarginal depression of sides, and the elytra with basal margination only laterally. In the ♂ the formation of legs as in *rotundicollis*, except for the posterior tibiæ (fig. 193) and the more strongly dilated anterior tarsi.

**Dimensions.** — Length  $9\frac{1}{4}$  to  $9\frac{3}{4}$  mm, width 4 to  $4\frac{3}{4}$  mm.

**Subspecies:** —

*a) monticola* s. str. — Head with round punctures on vertex; eyes convex, their outlines distinctly projecting beyond genæ. Pronotum

narrower, about one and a half times as broad as long, less strongly rounded and dilated behind middle, with slightly wavy and reflected lateral carina, very broad submarginal depression, weakly convex disc and much denser punctation on the latter, enclosing a fine, smooth median line. Elytra much more slender, with slightly obtuse, but not prominent humeral angles; apart from the flat sutural interval, all intervals sharply to obtusely costate also on disc; the seventh costa evanescent apically and not in contact with the two coalescent third costæ; the discal portion of the inner primary rows only slightly narrower than the intervening costæ.

*Distribution.* — South-eastern part of the South-western Cape Province. — Seven Weeks Poort Berg, 5,500 to 7,000 ft., XII.1928, K. H. BARNARD (1♂, holotype S.A.M.).

*b) dilatatus* n. subsp. — Head with longitudinally rugose sculpture on vertex; eyes flat, their outlines continuous with those of genæ. Pronotum much broader, about one and two thirds times as broad as long, very strongly rounded and dilated behind middle, with thick, evenly rounded and not reflected lateral carina, narrower submarginal depression, rather strongly convex disc, less densely punctured and without smooth median line. Elytra very broad, with dentiform projecting humeral angle; only the five outer intervals clearly costate, all the other inner intervals slightly convex to flat on disc; the apex of the seventh costa obtuse but in contact with the two coalescent third costæ; the discal portion of the inner primary rows several times narrower than the broad intervening intervals.

*Distribution.* — South-eastern part of the South-western Cape Province. — Seven Weeks Poort, II.1932, K. H. BARNARD (1♀, holotype S.A.M.).

16. Elytra with sharply costate outer intervals. Sides of pronotum posteriorly subparallel, slightly narrowed or dilated, or briefly sinuate in front of posterior angles. Upper surface of body bare or with only microscopically short bristles ..... 17
- Elytra, with the exception of the marginal carina on ninth interval, not costate, with plane intervals. Sides of pronotum almost as strongly rounded and narrowed towards base as to the anterior margin. Upper surface of body with conspicuous, yellowish bristles.

[*Zadenos (Euzadenos) incostatus* n. sp.]

(Pl. XXVI, fig. 4.)

Among all the other *Zadenos* readily recognizable by the absence of dorsal costæ. Related to *Z. bistratus*, but differing by the less deep, rather shallow emargination of epistome, the slender antennæ, the more strongly convex pronotum, exhibiting a finer punctation

but no submarginal depression of sides, as well as by the shoulderless, laterally rounded elytra. ♂ unknown.

Dimensions. — Length  $5\frac{1}{2}$  to  $5\frac{3}{4}$  mm, width  $2\frac{3}{4}$  to  $3\frac{1}{4}$  mm.

Distribution. — Southern Portuguese East Africa. — Masiene, XII.1923, R. F. LAWRENCE (3 ♀ ♀, holotype S.A.M.).

17. The second and third elytral costæ abbreviated apically, ending at short distance from apex of elytra, but neither reaching the latter nor in contact with the apex of suture. Sides of pronotum posteriorly subparallel or slightly narrowed or dilated towards base. Head with coarse, rugose punctures on vertex, and with the two clypeal foveæ grown together to a continuous, transverse impression, dividing frons from epistome ..... 18
- Either the second or the third elytral costa prolonged apically, reaching the extreme apex of elytra and there bent towards, and in contact with, the suture. Sides of pronotum either briefly sinuate in front of posterior angles or subparallel posteriorly, but in this case the head with fine, well separated, round punctures, and the two clypeal foveæ widely separated one from another ..... 19
18. Body moderately convex above. Sides of pronotum posteriorly subparallel to slightly narrowed, including the greatest width on middle; discal punctures rather coarse, only slightly finer than punctures on head. Base of elytra a little broader than pronotal base; intervals densely to almost rugosely punctured; apart from the three sharply costate outer intervals also the third to fifth intervals subcostate to strongly convex.

[*Zadenos (Euzadenos) bistriatus* (FAIRMAIRE).]

(Pl. XXVII, fig. 1.)

\*1899, *Oncotus bistriatus* FAIRMAIRE, p. 180. — 1910 b, GEBIEN, p. 271. — 1938 1942, GEBIEN, p. 393, n° 5137. — 1954 a, KOCH, p. 92.  
1953 a, *Zadenos bistriatus* KOCH, p. 274.

Original description. — «Long. 5 mm. — Oblongo-ovatus, modice convexus, niger, nitidus, antennis, palpis pedibusque piceis; capite dense sat subtiliter punctato-ruguloso, inter antennæ transversim impresso, clypeo antice piceo et sat late arcuatim emarginato; antennis sat crassis, prothoracis basin haud attingentibus; prothorace transverse, elytris vix angustiore, antice a medio arcuatim angustato, dorso sat dense ruguloso-punctato, postice utrinque stria parum impressa signato, margine postico ante angulos sat fortiter sinuato, his sat acutis, anticis obtusis; elytris ovatis, ad humeros sat angulatis, apice angustatis et obtuse angulatis, dorso cum sutura sat acute costatis, interstitiis latis, grosse punctatis, suturam versus tenuibus; epipleuris seriatim punctatis; pectore punctato, abdomine fere lævi. — Ressemble assez à l'*O. tardus* SOLIER, mais plus petit, avec la tête

et le corselet bien plus fortement ponctués, ce dernier plus court, marqué de deux stries basilaires, les antennes plus épaisses, les élytres à côtés assez tranchants, les intervalles très grossièrement ponctués.»

Remarks. — *Z. bistriatus* resembles slightly the *Oncotin Capidium tardum* (SOLIER), but is clearly defined as a *Litoborin* by the structure of ædeagus, the non-stridulatory gula and the many other tribal particulars.

Body oval, moderately shiny. Eyes convex. Pronotum broadest at about middle, about one and a half times as broad as long or more slender, with narrow submarginal depression of sides, strongly rounded and narrowed towards anterior margin, posteriorly not quite subparallel, but very slightly rounded and narrowed towards base. Base considerably broader than anterior margin, bi-sinuate, with rectangular to slightly obtuse posterior angles. Punctures with microscopically short bristles. Elytra rounded laterally, with coarsely punctured primary rows and costate outer intervals. Abdomen with uniform, rather strong, setiferous punctation. In the ♂ the anterior tarsi moderately dilated, with transverse second and third segments; the underside of anterior tibiæ with median excavation, but straight inner contours, with very fine and short bristles along middle; the intermediate and posterior legs simple.

Ædeagus. — The lateral contours of ædeagal tegmen strongly narrowed in a straight line from about middle to the briefly pointed apex; parameres closely attached to one another, not gaping apically and divided only by a very fine median suture.

Dimensions. — Length 5 to 5  $\frac{3}{4}$  mm, width 2  $\frac{1}{2}$  to 2  $\frac{3}{4}$  mm.

Subspecies: —

a) *bistriatus* s. str. — Apart from the five sharply costate outer intervals of elytra also the third and fourth of the inner intervals less sharply but distinctly costate; the sutural and the second intervals flat.

Type locality. — «Delagoa». Type probably in Museum Paris.

Distribution. — Southern Portuguese East Africa. — Lourenço Marques, IV and XI.1951, A. J. BARBOSA (2♂♂, 1♀, C.I.C.A. and T.M.); Rikatla, Delagoa (1♀, probably paratype, S.A.M.). — Zululand — Gollel, VII.1938, R. F. LAWRENCE (1♀, S.A.M.).

b) *paucicosta* n. subsp. — Elytra with three sharply costate outer intervals, obtusely costate fifth and sixth intervals, and with the third and fourth intervals convex, but not distinctly carinate, at the best slightly tectiform basally; sutural and second intervals flat.

Distribution. — Southern Portuguese East Africa. — Inhambane, I.1924, R. F. LAWRENCE (1♀, holotype S.A.M.).



*c) pluricosta* n. subsp. (Pl. XXVII, fig. 1) — All intervals on elytra sharply costate; the sutural interval strongly convex, subtectiform, with the basal portion sharply carinate, running obliquely outwards towards base.

**Distribution.** — Eastern Transvaal. — Nelspruit, I.1939, R. F. LAWRENCE (1♀, holotype S.A.M.).

- Body depressed above. Sides of pronotum gradually dilated posteriorly, including the greatest width of pronotum between posterior angles; discal punctures fine, considerably finer than punctures on head. Base of elytra rather much broader than pronotal base, with the humeral angles strongly projecting outwards beyond lateral outlines of pronotum; intervals with very fine, scattered punctures; apart from the three sharply costate outer intervals only the fifth and sixth intervals finely carinate, but the four inner intervals entirely flat.

[**Zadenos (Euzadenos) externus** n. sp.]

(Pl. XXXI, fig. 1; Fig. 194) <sup>(1)</sup>.

A peculiar species, in the shape of the externally costate elytra resembling the Stizopin *Blenosia costimargo* KOCH from Great Namaqualand. Related to *Z. bistriatus*, but showing somewhat allied also to *Z. omeri* on account of the fine punctation on pronotum and elytra. Differing from *bistriatus* by the more strongly dilated, securiform apical segment of maxillary palpi, more prominent eyes, but with the same coarse punctation on upper surface of head. Pronotum broadest at base, there slightly more than one and a half times as broad as long, uniformly covered with fine and well separated punctures, becoming stronger on lateral portions. The flattened elytra much broader than anterior body, with entirely flat four inner intervals, but sharply and strongly raised outer costæ; primary rows with rather coarse punctures, finer than in *bistriatus*. Punctation on abdomen finer. In the ♂ the anterior tarsi dilated, with transverse second and third segments; the anterior tibiæ (fig. 194) with deep, smooth, elongate excavation on median two-quarters, the inner contours strongly dilated in front of middle, thence subparallel and bearing a few fine, squarrose hairs; the intermediate and posterior legs simple.

**Dimensions.** — Length 5 to 5  $\frac{1}{4}$  mm, width 2  $\frac{3}{4}$  to 3 mm.

**Distribution.** — Zululand. — St. Lucia Bay, XI.1920, H. W. BELL-MARLEY (2♂♂, holotype T.M.).

(1) Instead of the erroneous caption to fig. 1 on Plate XXXI (*Minorus sculpticeps* n. sp.) read correctly: *Zadenos (Euzadenos) externus* n. sp.

19. Head above with round and well separated punctures; frons with two conspicuous clypeal impressions. Pronotum uniformly covered with round, rather fine and well separated punctures, also on lateral portions; sides posteriorly subparallel, with simple rectangular posterior angles; anterior margin shallowly emarginated, with faintly produced and slightly obtuse anterior angles. Elytra weakly shiny, with fine punctation on intervals and strongly impressed, sublineate, regularly punctured primary rows; the costæ on intervals continuous and smooth; on apical declivity the second interval costate, its costa prolonged, reaching the extreme apex and there approximated to, and in contact with, the sutural angle, as well as coalescent with the apex of eighth costa.

[**Zadenos (Euzadenos) omeri** n. sp.]

(Pl. XXVII, fig. 3; Fig. 195.)

Owing to the subparallel shape of body, the round, uniform and separated punctation on the shiny pronotum, as well as by the similar structure of ædeagus clearly related to *Z. algoensis*, but of the small size of the species of *bistriatus*-group. Differing from *algoensis* by the wider head, the short antennæ, the third segment of which is only one and a half times as long as broad (about twice as long as broad in *algoensis*), with the fourth segment being only a little longer than broad and just a trifle longer than the knob-like, square fifth segment (in *algoensis* the fourth segment is almost two-thirds longer than broad and considerably longer than the elongate fifth segment), the sides of pronotum which become narrowed at the anterior third (at about middle in *algoensis*), the coarser punctures of primary rows on elytra, the apically costate second interval (flat in *algoensis*), and by the formation of the legs in the ♂.

*Z. omeri* is easily recognized from *Z. bistriatus* by the slender, subparallel and bare body, the sculpture on upper surface of head, the subsquare shape of pronotum the sides of which are parallel on basal two-thirds, becoming weakly narrowed only on anterior third, the base of pronotum therefore only moderately broader than anterior margin, the fine, well separated and bare punctures on pronotum, the formation of elytral intervals which are all costate on apical declivity, with the second costa extending to sutural angle of apex, and by the formation of the legs in the ♂.

The elytra are about as broad as pronotum, with minutely and dentiform prominent humeral angle; the four outer intervals are sharply costate, the fourth and fifth intervals strongly convex to sub-tectiform discally, whereas the sutural and second intervals are flat, becoming raised and costate towards apex. Legs red to testaceous. In the ♂ (fig. 195) the anterior tarsi well dilated, with transverse

second and third segments; the anterior tibiæ excavate underneath, with the inner contours rather strongly dilated in front of middle and then very faintly emarginated; the intermediate tibiæ distinctly curved on proximal half, with the inner contours rather strongly dilated on distal half; the posterior tibiæ straight, but with a fringe of fine, dense and squarrose hairs on underside; and the underside of posterior femora with a subtomentose stripe of fine hairs on either of the lateral edges of underside.

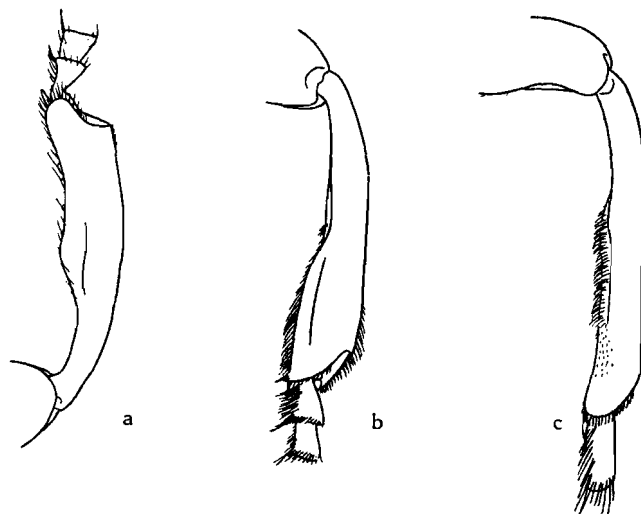

FIG. 195. — *Zadenos (Euzadenos) omeri* n. sp.

a: anterior tibia of ♂; b: intermediate tibia of ♂; c: posterior tibia of ♂.

**Ædeagus.** — Parameres strongly narrowed in a straight line to apical portion, deeply divided, with subparallel, gaping, obtuse apices which are strongly bent ventrad.

**Dimensions.** — Length  $4 \frac{3}{4}$  to 5 mm, width ca. 2 mm.

**Distribution.** — Central part of the Southern Cape Province. — Algoa Bay, H. BRAUNS (4 ♂♂, holotype T.M.).

**Dedication.** — Named in honour of Prof. J. OMER-COOPER, Rhodes University, Grahamstown.

- Head above with very dense, rugosely confluent, coarse punctation; frons almost plane, with very shallow, scarcely discernible and transverse epistomal impression. Pronotum with very dense, fine and slightly elongate punctures on disc, becoming longitudinally confluent on lateral

portions; sides posteriorly rounded, distinctly narrowed and briefly sinuate in front of the well demarcated, sharply rectangular posterior angles; anterior margin strongly emarginated, with produced and sharply rectangular, pointed anterior angles. Elytra strongly shiny, with rather strong, irregular punctures on intervals, slightly intermixed with the shallow, less well arranged, in part badly defined, coarser punctures of primary rows; the latter not sublineate; the costæ on outer intervals continuous, but crenulate, on inner intervals resolved to widely separated, fine granules or elongate tubercles; on apical declivity the second interval flat, but the third interval costate, approximated to, and reaching, the sutural apex, there coalescent with the seventh costa.

[**Zadenos (Euzadenos) acutangulus** n. sp.]

Closely related to *Z. omeri*, and, apart from the above mentioned characters, differing by the less subparallel shape of body, the slender and elongate antennæ (in this regard rather well agreeing with *algoensis*), shape and sculpture of elytra. The latter with the same, minutely prominent humeral angle as in *omeri*, but their sides are rounded and narrowed towards base; the five outer intervals are distinctly costate, with the crest of costæ becoming gradually more densely and intensely crenulate to subtuberculate towards disc; inner intervals tectiform, with sparse, fine granules or tubercles, particularly on apical third. In the ♂ the anterior tarsi moderately dilated, with transverse second and third segments; the anterior tibiæ with slightly curved outer contours, but with the inner contours straight and furnished with a fringe of fine, sparse, squarrose hairs; intermediate legs simple; the posterior tibiæ straight, with a fringe of fine hairs, as can be observed also on underside of posterior femora.

Dimensions. — Length 5 to 5  $\frac{1}{4}$  mm, width 2  $\frac{1}{4}$  mm.

Distribution. — Central part of the Southern Cape Province. — Keurbooms River, Knysna District, 1.1931, K. H. BARNARD (1 ♂, holotype S.A.M.).

20. Size of body larger, 6  $\frac{1}{2}$  to 12 mm long. The apical construction of elytral costæ variable, but the eighth costa always strongly abbreviate, posteriorly ending at considerable distance from elytral apex and much shorter than the ninth or seventh costæ posteriorly ..... 21
- Side of body small, only 5  $\frac{1}{4}$  mm long. On apical declivity of elytra the eighth costa complete and prolonged, much longer than the ninth and seventh costæ, reaching the sutural angle of apex and there the eighth costæ of both elytra practically coalescent.

**[Zadenos (Euzadenos) gnophotoides n. sp.]**

(Pl. XXVII, fig. 4.)

A peculiar species which, morphologically and geographically, is sharply separated from all the other species of genus. Strongly shiny, bare, black, the maxillary palpi testaceous, legs and antennæ of a more or less pale reddish brown colour. Head above coarsely, densely punctured. Clypeal impressions foveolate. Lateral portions of epistome not separated from outer contours of genæ. The latter short and slightly narrowed towards eyes. Eyes barely constricted by genal canthus, strongly convex, with the outer contours considerably projecting beyond lateral outlines of head. Mentum cordiform and concave. Maxillary palpi with securiform apical segment. Antennæ long, extending to base of pronotum, moderately accrescent towards apex, with fine, yellowish hairs; third segment rather short, barely longer than the thickened basal segment and not quite one and a half times as long as the second segment; the fourth segment only a little shorter than the third one; the ninth segment triangular, a trifle longer than broad; the tenth segment roundish to slightly transverse. Pronotum strongly transverse, broadest at about middle, more than three-quarters broader than long, slightly broader than elytra, with the sides very strongly rounded and deeply sinuate in front of the sharply rectangular, prominent posterior angles. Disc rather strongly convex, submarginal depression broad. Integument with extremely dense, coarse, substriolate sculpture, becoming resolved to a dense, coarse, round punctation on lateral portions, separated from the lateral carina by a narrow, smoothed submarginal canaliculation. Anterior emargination moderately strong, with slightly arcuate median portion. Base distinctly carinate only laterally, almost-straight, but with sharply produced posterior angles. Episternum of prosternum with dense, coarse, longitudinally confluent, substriolate sculpture on the sloping inner portion, with shallow, transverse wrinkles on the rather broad, flattened lateral portion; prosternal apophysis bent towards foramen behind coxal cavities. Elytra strongly shiny, basally not broader than pronotal base, with very weakly rounded sides and rectangular humeral angle which is demarcated from sides by a rather deep sinuosity. Primary rows with coarse and regular punctures; all intervals, the sutural interval included, sharply costate; the third and seventh costæ coalescent at considerable distance from apex; the ninth costa strongly abbreviated posteriorly, not in contact with the pseudopleural carina. The two coarsely punctured primary rows on reflected lateral portion of elytra separated from each other by a very fine, rudimentary costula on anterior half of tenth interval. Pseudopleura with a row

of very coarse punctures. Abdomen with rather strong, moderately dense and setiferous punctures which are much finer than the foveolate punctures of pseudopleura and become fine and scattered on apical half of anal sternite. In the ♂ the anterior tarsi rather weakly dilated, but with strongly transverse second and third segments; all tibiæ straight, the underside of anterior tibiæ shallowly concave and smooth, that of posterior tibiæ with a fringe of fine hairs, as can be observed also on the underside of posterior femora.

**Dimensions.** — Length 5 to 5  $\frac{1}{4}$  mm, width 2  $\frac{1}{2}$  mm.

**Distribution.** — Northern Transvaal. — Louis Trichardt, Zoutpansberg, 4,500 ft., II.1928, R. F. LAWRENCE (1♂, holotype S.A.M.).

21. The tenth interval on reflected lateral portion of elytra plane and not costate ..... 22  
 — The tenth interval on reflected lateral portion of elytra with a finely carinate costula which is often briefly interrupted.

[**Zadenos (Euzadenos) lightfooti** n. sp.]

Belonging to the *bohemani* group and agreeing with the species of this group in the identical construction of the apical portion of elytral costæ, the not costate sutural interval, and the similar shape of body. Readily distinguished by the supplementary costula on reflected portion of elytra, the intensely dull upper surface of body and the very dense, subrugose sculpture on upper surface of intermediate and posterior tibiæ. Head above covered with an extremely dense, rugosely confluent punctation. Eyes not projecting beyond the subparallel genæ. Antennæ rather slender, but strongly accrescent towards apex, with moderately transverse two penultimate segments. Pronotum slender, broadest behind middle, one and a third (♂) to one and a half times (♀) as broad as long, covered with extremely dense, short, longitudinal rugosities. Sides moderately rounded, shallowly sinuate in front of posterior angles and followed by a rather shallow submarginal depression. Anterior emargination strong, base strongly bi-sinuate. Prosternum as in *bohemani*. Elytra very dull, scarcely (♂) to distinctly (♀) broader than pronotum, with weakly rounded sides, almost subparallel in the ♂. Humeral angle minutely demarcated in the ♂, obtuse and in line with elytral sides in the ♀. Primary rows with fine punctures which are much finer than those on pronotal disc. Intervals without conspicuous punctation, sharply costate, but the costæ becoming very fine, crenulate to subgranulate towards the suture; sutural interval finely carinate to subgranulate posteriorly; apical construction of costæ as in *bohemani*. Abdomen densely punctured, with the punctures becoming finer but concentrated on posterior half

of anal sternite. Upper surface of tibiæ rugosely sculptured, but not opaque, that of anterior tibiæ uniformly convex and not edged. In the ♂ the anterior tarsi dilated, with transverse second and third segments; the underside of all tibiæ and femora with a fringe of squarrose hairs; the anterior tibiæ slightly curved, the intermediate and posterior ones straight.

**Dimensions.** — Length  $8\frac{1}{2}$  to  $8\frac{3}{4}$  mm, width  $3\frac{1}{2}$  to  $3\frac{3}{4}$  mm.

**Distribution.** — Southern part of the South-western Cape Province. — Malmesbury, R. LIGHTFOOT (1♂ ♀, types S.A.M.).

- 22.** Inner intervals on elytra with scattered, fine tubercles at least on posterior third. Pronotum strongly cordiform, with the sides strongly rounded and deeply sinuate in front of posterior angles; the latter sharp, slightly acute to rectangular ..... **23**
- Inner intervals on elytra convex or costate, in the latter case the crest of costæ smooth, crenulate or subgranulate. Pronotum of variable shape, but not strongly cordiform, with the sides rounded, narrowed or shallowly sinuate posteriorly; posterior angles obtuse to rectangular, not prominent ..... **24**
- 23.** Sexual dimorphism in shape and sculpture of elytra scarcely pronounced : the sides in both sexes rounded and narrowed towards the humeral tooth, dilated towards middle and there the elytra considerably broader than pronotum; primary rows fine, with their punctures badly demarcated from the rather dense and stronger punctures of intervals; the inner intervals with well separated tubercles also on anterior half.

[**Zadenos (Euzadenos) tuberculatus** n. sp.]

(Pl. XXVIII, fig. 1.)

Head above and pronotum shiny, the elytra opaque, with shiny secondary elements of sculpture. Head above rugosely punctured, with shallow, transverse epistomal impression. Genæ parallel; eyes very slightly projecting outwards. Antennæ long, extending to pronotal base; segments elongate, with the exception of the slightly transverse two preapical segments. Pronotum broadest behind middle, strongly transverse, about one and two thirds times as broad as long, weakly convex, with narrow submarginal depression, bare, uniformly covered with an extremely dense, longitudinally confluent rugose sculpture. Anterior margin deeply emarginate, with produced and sharp anterior angles. Base scarcely bi-sinuate, straight, with the posterior angles considerably produced backwards. Prosternal apophysis horizontally produced, with obtusely pointed apex. Elytra broader than pronotum, rather strongly convex, rounded laterally, with prominent and dentiform humeral angle.

On apical declivity the two third costæ angularly bent towards suture in front of apex and in contact with sutural angle apically. Abdomen with uniform, rather scattered, fine punctures on proximal four sternites, there between punctures densely and longitudinally wrinkled on disc; anal sternite with concentrated punctation on posterior half. In the ♂ the anterior tarsi strongly dilated, with the second and third segments about twice as broad as long; the anterior tibiæ excavate underneath and with the inner contours slightly dilated and pilose on distal half; the intermediate tarsi likewise rather strongly dilated and the intermediate tibiæ simple, with slightly curved inner angle of apex; the posterior tibiæ with a dense brush of yellowish hairs on underside, the inner contours shallowly emarginate on distal two-thirds (with the outer contours following the course of the inner contours, therefore being slightly curved) and the inner apical angle distinctly curved inwards and bearing a minute, sharply pointed, transversely prominent spinula on extreme apex, inserted very close to tibial calcaria; posterior femora with a fine stripe of squarrose, dense hairs on underside.

*Ædeagus*. — The lateral contours of apical portion not demarcated from basal portion, strongly narrowed in a straight line towards apex, bent ventrad on distal half. Parameres deeply divided, only weakly gaping, with sharply pointed, angularly bent extreme apices.

*Remarks*. — On account of the tuberculate elytra resembling *Hadroderus tuberculiferus*, as well as *Z. natalensis*. From the latter readily distinguished by the strongly cordiform, bare and substriolate pronotum, the strongly prominent, large humeral tooth, the two apically coalescent third costæ on elytra, the bare abdomen, and the formation of legs in the ♂. Very characteristic for this species are the apically deeply emarginated, almost bi-lobate third segments on anterior and intermediate tarsi, partially enclosing the small penultimate segments.

*Dimensions*. — Length  $8\frac{1}{2}$  to  $9\frac{3}{4}$  mm, width  $3\frac{3}{4}$  to  $4\frac{1}{2}$  mm.

*Distribution*. — Central part of the Southern Cape Province. — George, XI.1913, H. BRAUNS (1♂, holotype T.M.); Knysna, X.1949, B. MALKIN (1♀, allotype T.M.); Keurbooms River, Knysna District, I.1931, K. H. BARNARD (3♀, S.A.M.).

- Sexual dimorphism in shape and sculpture of elytra strongly pronounced: the sides in the ♀ more strongly rounded and dilated towards middle than in the ♂, in the latter the elytra only a trifle broader than pronotum; primary rows rather strong, well demarcated; intervals in the ♀ with scattered and very fine punctation, in the ♂ appearing as if impunctate; the inner intervals finely and continuously costate on anterior half.



[**Zadenos (Euzadenos) georgensis** n. sp.]

(Pl. XXVIII, fig. 2.)

Very closely related to *Z. tuberculatus*, but of smaller size, the elytra in the ♂ narrower, more shiny, the sutural interval strongly convex and all the other intervals continuously costate on anterior half, with the crest of costæ more or less distinctly crenulate to subtuberculate. In the ♂ the legs identically shaped, but the underside of posterior femora with fringe of long, fine and sparse hairs. *Ædeagus* similar to *tuberculatus*; the apex of apical portion, in dorsal view, appearing as if subtruncate, as the extremely fine apices of parameres are strongly bent ventrad and inwards, forming sharp hooks.

**Dimensions.** — Length  $7\frac{3}{4}$  to  $8\frac{1}{4}$  mm, width  $3\frac{1}{4}$  to  $3\frac{3}{4}$  mm.

**Distribution.** — Central part of the Southern Cape Province. — George District, VIII.1931, C. THORNE (3 ♂, 1 ♀, types S.A.M.).

24. Body small,  $6\frac{1}{2}$  to 7 mm long ..... 25  
 — Body larger,  $8\frac{1}{2}$  to 12 mm long ..... 26
25. Upper surface of body dull. Antennæ stout, very strongly accrescent towards apex, with transverse three penultimate segments. Pronotum broadest in front of middle, with very shallow anterior emargination and the posterior portion of sides slightly narrowed in a straight line towards base; submarginal depression of sides very narrow, subcanaliculate; punctation very dense, rugose, but not longitudinally confluent. All intervals of elytra, the sutural interval included, sharply and completely costate, but only inconspicuously punctured. Penultimate segment of anterior tarsi very small, considerably shorter than the preceding segment along midline.

[**Zadenos (Euzadenos) bevisi** n. sp.]

Well characterized by having all elytral intervals provided with sharp, continuous and smooth costæ. Very closely related to *Z. lawrencei* and differing only by the shorter and stouter antennæ, the very dense, roundish but rugose punctation on pronotum, the practically impunctate intervals on elytra, the costate sutural interval, as well as by the very opaque upper surface of body. In the ♂ the legs as in *lawrencei*.

**Dimensions.** — Length  $6\frac{1}{2}$  mm, width 3 mm.

**Distribution.** — Natal. — Durban, C. N. BARK (1 ♂, holotype S.A.M.).

**Dedication.** — Named in honour of Mr. L. BEVIS, Entomologist to the Museum and Art Gallery, Durban.

- Upper surface of body shiny. Antennæ slender, faintly accrescent towards apex, with only the preapical segment distinctly transverse. Pronotum broadest at about middle, with very deep anterior emargination and strongly produced anterior angles; sides rounded and narrowed towards base, shallowly sinuate in front of posterior angles, and with broad submarginal depression; punctation longitudinally confluent, particularly on submarginal depression. Sutural interval on elytra not costate; of the remaining intervals the crest of the inner costæ very fine, crenulate to slightly subtuberculate; punctation on intervals dense and conspicuous. Penultimate segment of anterior tarsi rather large, about as long as the preceding segment along midline.

[**Zadenos (Euzadenos) visseri** n. sp.]

(Pl. XXVIII, fig. 3.)

Belonging to the *bohemani* group, but readily distinguished by the small size of body. Black; the maxillary palpi, tarsi and the distal portion of antennæ reddish brown to testaceous, the femora and tibiæ of a dark reddish brown tint. Head above densely and coarsely punctured, with shallow clypeal impressions on frons. Eyes not projecting outwards, with their straight outlines continuous with the subparallel contours of genæ and tempora. Pronotum slender, flat, a little less than one and a half times as broad as long, with rather strongly rounded, distinctly reflected and thickly marginate sides, and carinate, strongly bi-sinuate base. Prosternal apophysis obtusely narrowed apically. Elytra depressed, only slightly broader than pronotum, with the sides faintly rounded in the ♀, almost subparallel in the ♂. Humeral angle neither prominent nor demarcated, slightly obtuse to rectangular. Sutural interval plane, all the remaining intervals costate, but the inner costæ finer and with crenulate to subtuberculate crest; the third costa strengthened on basal third; on apical declivity both the third costæ angularly bent towards suture in front of apex, generally coalescent with the apex of seventh costa and in contact with the sutural angle apically. Reflected portion, together with pseudopleura densely punctured. Punctation on abdomen very dense, coarse, becoming finer on anal sternite. Tibiæ subcylindrical, the upper surface of intermediate and posterior tibiæ very densely covered with setiferous punctures. In the ♂ the anterior tarsi dilated, with transverse second and third segments; the underside of anterior tibiæ with the usual excavation, but with almost straight inner contours; the underside of anterior femora and of all tibiæ with fine, short hairs, concentrated only on distal half of intermediate tibiæ.

Ædeagus. — Apical portion not demarcated from basal portion, narrowed in a straight line towards apex, slightly bent ventrad on

apical third. Parameres thick, deeply divided, but scarcely gaping apically; the apices, in dorsal view, appearing as if subtruncate, as the short and pointed portion of extreme apex is angularly bent ventrad, forming a fine, transversely projecting hook (lateral aspect).

**Dimensions.** — Length  $6 \frac{1}{4}$  to 7 mm, width 3 to  $3 \frac{1}{2}$  mm.

**Distribution.** — Southern part of the South-western Cape Province. — Cape Town, 1896, F. W. PURCELL (3♂♂, 2♀♀, types S.A.M.); same locality, I.1887, L. PÉRINGUEY (2♂♂, 1♀, S.A.M.); Kalk Bay, I.1907 (1♂, S.A.M.); Sal-danha Bay, IX.1918, L. PÉRINGUEY (1♀, S.A.M.).

**Dedication.** — Named in honour of Mr. G. VISSER, of the Mountain Club of South Africa, Cape Town.

- 26.** On apical declivity of elytra the apex of seventh costa distinctly, often widely separated from third costa; the third costæ of both elytra angularly bent towards suture in front of apex and coalescent with sutural angle apically; intervals more or less distinctly shiny, the sutural interval plane, only exceptionally subcostate, when the entire elytra are strongly shiny; primary rows always well marked. Upper surface of tibiæ more or less shiny, that of anterior tibiæ not or only obsoletely edged ..... **27**
- On apical declivity of elytra either the apex of seventh costa coalescent with the prolonged third costa (in which case the third costæ of both elytra are in contact with each other at sutural angle of apex), or the seventh costæ of both elytra are prolonged in a straight line to the apex of elytra, where they meet at the sutural angle (in which case often the third costa is abbreviated, ending just in front of the prolonged seventh costa and does not clearly coalesce with the latter); intervals always very opaque; the sutural interval sharply costate, but sometimes the sutural costa extremely fine and scarcely discernible, when the primary rows are obsolescent. Upper surface of tibiæ opaque, in exceptional cases shiny, but then the body exhibiting clearly the preceding characters and the upper surface of anterior tibiæ with distinct fine edge, separating the upper surface from outer lateral one ..... **32**
- 27.** Pronotum with very broad and strong submarginal depression of sides, with distinctly upwardly bent lateral margination; the submarginal depression about a third the width of discal convexity (best examinable in caudal aspect). Sutural interval on elytra plane, flat to convex, only exceptionally tectiform or subcostate ..... **28**
- Pronotum with narrow and very weak submarginal depression of sides, with the strong lateral carina at about level with submarginal depression and not bent upwards; the submarginal depression about a fifth the width of discal convexity (best examinable in caudal aspect). Sutural interval on elytra distinctly costate.

[*Zadenos (Euzadenos) riversdalensis* n. sp.]

Although exhibiting the main characters of the *ruficornis-bohemani* group, this species resembles much *Z. costifer* because of the shape of pronotum.

Black, antennæ and tarsi reddish brown. Head as in *bohemani*, but the antennæ slightly shorter. Pronotum shaped and sculptured

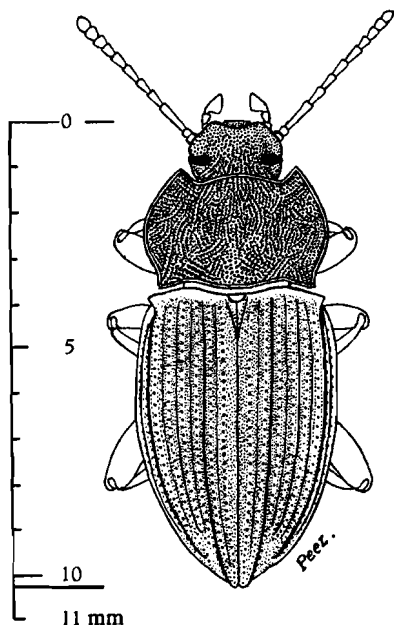

FIG. 196. — *Zadenos (Euzadenos) bohemani* (MULSANT & REY).

as in *costifer*, but the sides strongly sinuate in front of posterior angles. Elytra shiny, only slightly broader than pronotum, with weakly projecting humeral angles and moderately rounded sides. Primary rows with rather coarse punctures; intervals with inconspicuous punctation and strongly shiny costæ, sharply raised on outer intervals, becoming weaker and slightly obtuse on inner intervals. Abdomen with strong and rather dense punctures, concentrated but finer on anal sternite, longitudinally wrinkled between punctures on proximal sternites. Upper surface of tibiæ shiny, densely, but not rugosely punctured. ♂ unknown.

Dimensions. — Length  $9 \frac{3}{4}$  to  $10 \frac{1}{4}$  mm, width  $4 \frac{1}{4}$  to  $4 \frac{1}{2}$  mm.

Distribution. — Southern part of the South-western Cape Province. — Riversdale Mountains, X.1926. K. H. BARNARD (3 ♀♀, holotype S.A.M.).

28. Upper surface of posterior tibiæ strongly shiny, with scattered to moderately dense, round and separated punctures. Either the inner costæ on elytra with more or less distinctly crenulate crest or the broad submarginal depression of pronotal sides with rather scattered, round and scarcely confluent punctures. In the ♂ the anterior femora simple, without brush ..... 29
- Upper surface of posterior tibiæ moderately to weakly shiny, with partially very dense, subrugose to longitudinally confluent punctures. All the elytral costæ with smooth crest and the submarginal depression of pronotal sides with extremely dense, rugosely confluent sculpture. In the ♂ the anterior femora with brush ..... 30
29. Submarginal depression of sides of pronotum less broad and weaker, with extremely dense, rugose sculpture; sides shallowly sinuate in front of posterior angles. Elytra with sericeous sheen, the inner costæ sharp, but with more or less crenulate to subgranulate crest.

[**Zadenos (Euzadenos) bohemani** (MULSANT & REY).]

(Pl. XXVIII, fig. 4; Fig. 196.)

\*1854 a, *Eurynotus (Zadenos) bohemani* MULSANT & REY, pp. 178, 180. — 1854 b, MULSANT & REY, p. 36.

1870, *Eurynotus bohemani* GEMMINGER & DE HAROLD, p. 1914. — 1910 b, GEBIEN, p. 275. — 1938-1942, GEBIEN, p. 414, n° 5542.

Original description. — «Long. 9 mm, larg. 3,9 mm — Corps oblong; obtusément arqué longitudinalement, c'est-à-dire presque plan depuis les quatre-septièmes du prothorax jusqu'à la moitié des élytres; très faiblement convexe transversalement; d'un noir mat. Antennes d'un brun rouge. Prothorax arqué sur les côtés, sensiblement sinué près des angles postérieurs qui sont un peu dirigés en dehors; bisinué à la base; faiblement convexe en dessus, sur les deux-tiers médiaires de sa surface, médiocrement relevé sur les côtés, et formant par là, entre ceux-ci et la partie médiaire, une gouttière large et peu profonde, dont le centre semble dirigé vers le point du bord postérieur formant à peu près les trois-cinquièmes de l'espace existant entre chaque sinuosité basilaire et l'angle de derrière; offrant les traces plus ou moins apparentes d'une ligne longitudinale médiaire ou d'un sillon léger un peu plus déprimé ou formant une très légère fossette au-devant de la base; présentant les traces moins distinctes de deux fossettes à peine apparentes, situées chacune près de la base, entre la ligne médiane et chaque sinuosité basilaire. Elytres obtusément arrondies à l'extrémité et à peine sinuées latéralement près de celle-ci: la troisième au moins aussi saillante en

devant que la septième, aboutissant à l'angle sutural, en s'incurvant vers celui-ci : la septième non liée postérieurement à la troisième : les sillons ruguleusement et finement ponctués, et marqués chacun d'une rangée longitudinale de points moins petits. Prosternum rétréci en pointe et relevé à son extrémité. Tibias antérieurs presque cylindriques. ♂ Jambes antérieures et postérieures et plus brièvement les cuisses de derrière, ciliées. Trois premiers articles des tarsi antérieurs garnis en dessous d'une brosse serrée ou de sortes de ventouses : le deuxième et troisième articles dilatés. ♀ Jambes glabres. Tarsi sans ventouses ni brosse, non dilatés. »

Remarks. — Head above densely and rugosely punctured. Clypeal sutures arcuate and deeply impressed. Genæ straight and subparallel. The lateral outlines of eyes only minutely prominent. Antennæ elongate, accrescent towards apex, with moderately transverse two penultimate segments. Pronotum broadest behind middle, one and a half (♂) to one and two thirds times (♀) as broad as long, with deeply emarginate anterior margin and strongly produced, sharply rectangular anterior angles, uniformly covered with an extremely dense, in part longitudinally confluent rugose sculpture. Elytra broader than pronotum, with prominent humeral angle, subcarinate base and with the sides more strongly dilated towards the middle in the ♀ than in the ♂. The four to five outer costæ sharply raised, the inner ones weaker, often obtuse, the sutural interval convex to slightly tectiform. Abdomen with scattered punctation on proximal four sternites, longitudinally wrinkled between punctures; the anal sternite with uniform, very dense and finer punctation. In the ♂ the anterior tarsi strongly dilated, with transverse second and third sternites; the anterior tibiae slightly curved, excavate below and there pilose; the intermediate and posterior tibiae straight, but the inner apical angle briefly curved inwards and with a minute spine at extreme apex; the underside of posterior tibiae and femora with a fine, subtomentose stripe of very short, yellowish, depressed hairs.

Ædeagus. — Lateral contours of apical portion not demarcated from basal one, strongly narrowed in a straight line towards apex; parameres deeply divided, with sharply pointed apices which are briefly bent ventrad and form a short hook. Penis with elongately oval apical portion; lacinia about as broad as penis, with the obtusely rounded apices bent outwards.

Dimensions. — Length  $8 \frac{1}{4}$  to  $10 \frac{3}{4}$  mm, width 4 to  $5 \frac{1}{4}$  mm.

Type locality. — « Le Cap de Bonne-Espérance », type probably in Museum Paris.

*Distribution.* — Cape Peninsula. — Table Mountain (T.M., S.A.M.); Blinkwater Ravine (T.M., M.C.A.); Orange Kloof, Wynberg (S.A.M.); Rondebosch (S.A.M.); Karbonkelberg, Hout Bay (S.A.M.); Noordhoek (S.A.M.).

- Submarginal depression of sides of pronotum very broad, deep, abruptly demarcated from discal convexity, covered with coarse, round only slightly rugose punctures; sides deeply sinuate in front of the sharp posterior angles. Elytra shiny, the inner costæ weak and tending to become flattened, but with smooth crest.

[**Zadenos (Euzadenos) sulcimargo** n. sp.]

(Pl. XXIX, fig. 1.)

Very closely related to *Z. bohemani*, but the upper surface shiny and the body more elongate, also in the ♀ with subparallel to weakly rounded sides of elytra. Head as in *bohemani*, but the anterior margin of labrum not carinate, the lateral contours of epistome more distinctly demarcated from genæ and the eyes rather strongly prominent. Pronotum strongly transverse, about two-thirds broader than long, with slightly wavy lateral carina, covered with a much less dense punctation which is roundish and moderately confluent on disc, scattered on a smoothed median patch close to anterior margin. Elytral intervals densely punctured; only the three outer costæ strongly raised, all the remaining inner costæ weak, becoming obtuse and flattened towards suture. The punctation on upper surface of intermediate and posterior tibiæ fine, scattered, much less dense than in *bohemani*. ♂ unknown.

*Dimensions.* — Length  $10 \frac{3}{4}$  to 12 mm, width  $4 \frac{3}{4}$  to 5 mm.

*Distribution.* — Southern part of South-western Cape Province. — Swellendam, XI.1925, Mus. Exped. (1♀, holotype S.A.M.), same locality (1♀, S.A.M.).

30. Pronotum moderately transverse, in the ♂ about one and a half times, in the ♀ one and two thirds times as broad as long, in both sexes narrower than elytra; sides moderately rounded and elongately sinuate in front of posterior angles; submarginal depression from moderately strong to rather weak, with black background of cuticle and the lateral margination moderately reflected. In the ♂ the anterior tarsi normally dilated, with distinctly transverse second segment and strongly transverse third one ..... 31
- Pronotum very strongly transverse, in both sexes about twice as broad as long, but in the ♂ about as broad as elytra or even slightly broader; sides very strongly rounded, with obtuse or briefly demarcated rectangular posterior angles; submarginal depression very strong, deep and

of a transparent brownish tint; the lateral margination strongly bent upwards. In the ♂ the anterior tarsi dilated as well as prolonged; the second segment long, distinctly longer than broad, the third segment only square.

[**Zadenos (Euzadenos) ruficornis** (GERMAR).]

(Pl. XXIX, fig. 2.)

\*1824, *Pedinus ruficornis* GERMAR, pp. 141, 236.

1854 a, *Eurynotus (Zadenos) ruficornis* MULSANT & REY, p. 178. — 1854 b, MULSANT & REY, p. 34.

1870, *Eurynotus ruficornis* GEMMINGER & DE HAROLD, p. 276. — 1910 b, GEBIEN, p. 276.

Description (according to MULSANT & REY, 1854a, based on GERMAR's type). — « Long. 11,7 mm to 12,3 mm, larg. 4,5 to 5,4 mm. — Corps oblong; longitudinalement arqué; très-faiblement convexe; noir brun, d'un brun rougeâtre ou d'un rouge brun. Tête ponctuée, d'une manière râpeuse entre les yeux, et chargée entre ceux-ci d'une saillie transversale. Antennes à peine aussi longuement prolongées que les angles postérieurs du prothorax; le deuxième article, une fois plus long que le cinquième: les troisième à septième, plus longs que larges, presque filiformes: le huitième, obconique: les neuvième et dixième, moniliformes, plus larges que longs; le onzième, de moitié plus grand que le dixième. Prothorax arqué sur les côtés, offrant vers la moitié ou les quatre-septièmes de sa longueur sa plus grande largeur; sans sinuosité bien sensible près des angles postérieurs; d'un tiers environ plus large à la base qu'aux angles de devant; de deux-tiers au moins plus large à celle-là que long dans son milieu; bisinué à son bord postérieur, avec les trois-cinquièmes médiaires de celui-ci, légèrement arqués en arrière, et les angles postérieurs un peu prolongés en forme de large dent; muni d'un rebord étroit à la base; faiblement convexe sur les trois-cinquièmes médiaires de sa surface, relevé sur les côtés et formant par là entre ceux-ci et sa partie médiaire, une large gouttière dont le centre aboutit vers le point du bord postérieur intermédiaire entre la sinuosité et l'angle de derrière; réticuleusement ponctué; sans trace de sillon médiaire. Ecusson transverse. Elytres un peu plus larges en devant que le prothorax; munies à l'angle huméral d'une petite dent dirigée en dehors; élargies en ligne sensiblement courbe jusqu'à la moitié, en ogive un peu étroite et non sinuée près de l'extrémité, dans leur seconde moitié; faiblement convexes; subconvexement déclives longitudinalement à partir de la moitié de leur longueur; offrant en dessus huit sillons et neuf arêtes (y comprises les juxta-suturale et marginale): les sillons finement et légèrement ponctués et marqués chacun d'une rangée longitudinale de points moins



petits : les cinquième et septième arêtes et la majeure partie de la troisième, un peu plus saillantes que les autres : la troisième, affaiblie en devant moins saillante que la septième, postérieurement recourbée vers l'angle sutural, au-devant duquel elle s'unit à sa pareille de l'autre étui : la deuxième, presque aussi longue que la troisième : la septième, à peine moins longue, non liée à la troisième à son extrémité, aboutissant en devant à l'angle huméral en se courbant en dehors : la cinquième, prolongée jusqu'aux quatre-cinquièmes ou un peu plus : les quatrième, sixième, huitième, un peu plus courtes, affaiblies à leur extrémité : les deux intervalles voisins du repli paraissant n'en former qu'un; non séparés par une arête. Dessous du corps souvent moins obscur ou plus rougeâtre que le dessus; marqué de gros points sur les parties pectorales; ponctué plus finement sur le ventre. Prosternum tronqué et offrant sa plus grande largeur à son extrémité; souvent relevé en pointe ou chargé d'un tubercule vers le milieu de celle-ci. Pieds grêles; simples. ♂ Cuisses de devant, jambes antérieures et postérieures ciliées en dessous : les antérieures moins grêles que les autres. Trois premiers articles des tarsi antérieurs garnis de brosses ou de ventouses en dessous : les deuxième et troisième, dilatés. ♀ Cuisses et jambes glabres en dessous : les antérieures à peu près aussi grêles que les autres. Tarsi non pourvus de brosse ou de sortes de ventouses en dessous; à articles non dilatés. »

Remarks. — Closely related to *Z. bohemani* and occurring at the same localities. Readily distinguished from this species by the larger size of body, the partially brownish tint of upper surface, the less dense punctation on head and pronotum, the peculiar shape of the latter, the more strongly costate elytral intervals, the much denser, slightly confluent punctation on the only weakly shiny upper surface of posterior tibiae, and finally by the different formation of the anterior tarsi in the ♂. The structure of aedeagus is almost identical.

Dimensions. — Length  $10 \frac{1}{4}$  to  $12 \frac{1}{2}$  mm, width  $4 \frac{1}{2}$  to  $5 \frac{3}{4}$  mm.

Distribution. — Cape Peninsula. — Cape Town (S.A.M.); Cape Flats (S.A.M.).

31. In the ♂ the anterior tarsi strongly dilated, the anterior tibiae distinctly curved, the apical portion of intermediate and posterior tibiae curved inwards, the underside of posterior tibiae with broad and complete sub-tomentose stripe, and the underside of posterior femora with strongly developed brush of hairs.

[**Zadenos (Euzadenos) caledonicus** n. sp.]

(Pl. XXIX, fig. 3.)

Very closely related to *Z. bohemani*, but body more elongate, the pronotum strongly sinuate in front of posterior angles, with coarser sculpture and much narrower submarginal depression, the elytra with sharply costate inner intervals, the tibiae thicker and their upper surface only weakly shiny and more densely punctured; in the ♂ the formation of legs quite different.

Dimensions. — Length  $11 \frac{1}{4}$  mm, width  $4 \frac{1}{2}$  mm.

Distribution. — Southern part of the South-western Cape Province. — Hermanus, Caledon District, 1902, R. LIGHTFOOT (1♂, holotype S.A.M.).

- In the ♂ the anterior tarsi weakly dilated, all tibiae straight, the underside of the posterior tibiae with fine, subtomentose stripe which is abbreviate at both ends, and the underside of posterior femora with fine brush of hairs.

[**Zadenos (Euzadenos) babylomontis** n. sp.]

(Pl. XXIX, fig. 4.)

Very closely related to *Z. caledonicus*, but differing by the following characters. Body shorter, in the shape of elytra similar to *bohemani*. Antennae slightly shorter. Pronotum of similar shape, but the sides only shallowly sinuate in front of posterior angles or simply rounded and narrowed towards the latter; submarginal depression broad and deep; punctation less dense, rather scattered on middle of disc. Elytra shiny (sericeous in *caledonicus*), with similarly costate intervals, but coarser punctures of primary rows. Abdomen with less dense punctation, the anal sternite included. Punctation on upper surface of tibiae very dense, similar to that in *caledonicus*. Aedeagus similar to that of the species of the *bohemani* group, but the extreme apices of parameres straight and not bent ventrad.

Dimensions. — Length  $10 \frac{1}{4}$  to  $10 \frac{1}{2}$  mm, width  $4 \frac{1}{4}$  to  $4 \frac{3}{4}$  mm.

Distribution. — Southern part of the South-western Cape Province — Babylons Tower, III.1939, Mus. Staff (3♂♂, 1♀, types S.A.M.).

32. Body larger,  $8 \frac{1}{4}$  to  $10 \frac{1}{2}$  mm long. Eyes moderately convex, their outlines not projecting outwards, but in line with genal contours; the latter subparallel or slightly narrowed towards eyes. The sutural costa on elytra strong, its diameter about equal to the diameter of the third costa; the second, fourth and sixth intervals very variable, from sharply costate to practically plane ..... 33

- Body smaller,  $6 \frac{3}{4}$  to  $8 \frac{1}{2}$  mm long. Eyes strongly convex, their outlines distinctly projecting outwards and demarcated from genal contours; the latter strongly narrowed in a straight line towards eyes. The sutural costa on elytra from very fine to evanescent or absent, if developed its diameter much smaller than the diameter of the third costa; the second, fourth and sixth intervals with very fine, inconspicuous, sometimes rudimentary to evanescent costulae, in the latter case practically plane.

[**Zadenos (Euzadenos) acutus** (WIEDEMANN).]

(Figs. 197, 198.)

\*1823, *Opatrum acutum* WIEDEMANN, p. 33.

1870, *Eurynotus acutus* GEMMINGER & DE HAROLD, p. 1914. — 1910 b, GEBIEN, p. 275.

— 1938-1942, GEBIEN, p. 414, n° 5540.

Original description. — « Nigrum, antennis ochraceis, elytris triporcatis, interstitiis linea longitudinali rugulisque transversis. Longit. lin.  $3-3 \frac{1}{2}$ . — Der ganzen Gestalt nach nähert sich diese Art dem portugiesischen *O. angulatum* ILL., welches in FABRICIUS' Sammlung unter dem Namen *O. purpurascens* steckt, und sich auch von den übrigen durch die hinten spitz auslaufenden Deckschilde unterscheidet. Die Taster ragen wie bei *O. longipalpe* unter dem Kopfe hervor. Die Bildung des Kopfes ist ganz wie bei *O. longipalpe*. Fühler ockerbraun. Halsschild narbig, ohne Längsvertiefung, Seitenränder breit, aber wenig aufgebogen, convex, vorn mehr als hinten convergierend, Vorderrand breit ausgeschnitten, so dass er in der Mitte ziemlich gerade, an den Seiten aber schnell vor- und auswärts läuft, wodurch die vordern Ecken wie dreieckige Lappen vorragen. Hinterrand mitten flach convex, zu beiden Seiten unter einem sehr stumpfen Winkel rückwärts laufend, Flügeldecken jede mit drei scharf erhabenen Längslinien, zwischen denen eine sehr wenig erhabene feine Längslinie liegt, von der an jeder Seite Querfältchen abgehen; dieser feinen Längslinien sind vier, die innerste zwischen der Naht und der innern scharferhabenen Linie, die äusserste zwischen dem Aussenrande und der äusseren erhabenen Linie. Obere Fläche ohne Glanz; untere Fläche grob punktiert, wenig glänzend. Beine feiner punktiert, von Farbe bräunlich, an den Fusswurzeln ockerbraun. »

Remarks. — *Z. acutus* is very well characterized among the allies of *Z. bohemani* by the small size of body, the very opaque upper surface, the extremely dense, rugose and subgranular sculpture on pronotum, the convex eyes, the very long antennæ, and the peculiar sculpture on elytra. The latter exhibit three sharply costate outer intervals, whereas of the inner intervals only the third and

fifth ones are sharply costate; the sutural interval is often very finely carinate, but the second, fourth and sixth intervals show only very fine traces of carinæ or rows of fine granules; the seventh costæ of both elytra are prolonged in a straight line as far as the sutural angle of apex, where they are in contact with each other, forming a sharp, right angle apically; the apex of third costa usually in contact with the seventh costa, but often ending just in front of the

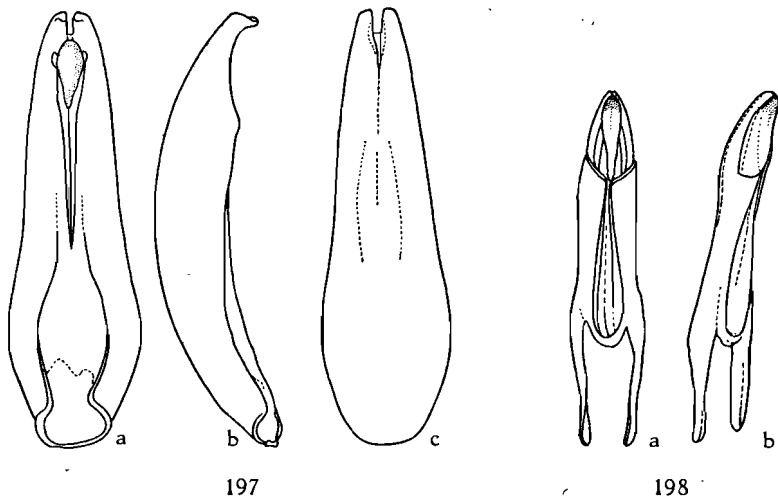

FIG. 197. — *Ædeagus* of *Zadenos (Euzadenos) acutus* (WIEDEMANN) (a: ventral surface; b: lateral view, with the ventral surface at right; c: dorsal surface). — FIG. 198. — The extracted penis plus lacinia of the *ædeagus* of *Zadenos (Euzadenos) acutus* (WIEDEMANN) (a: outer surface; b: diagonal view).

latter. Intervals with fine and dense granular sculpture and more or less distinct to obsolescent primary rows of punctures. Abdomen shiny, rather coarsely and densely punctured, with very dense punctation on anal sternite. Legs reddish brown to red; in the ♂ the anterior tarsi moderately dilated, with transverse second and third segments; the underside of anterior tibiæ with rather deep, elongately pilose median excavation; the intermediate and posterior tibiæ straight, the underside of the latter, as well as the underside of anterior and posterior femora with a fringe of fine hairs.

*Ædeagus* (figs. 197, 198). — Apical portion narrowed in a straight line to apex; the parameres deeply divided, gaping distally, with obtusely pointed apices which are moderately bent ventrad.

*Dimensions*. — Length  $6 \frac{3}{4}$  to  $8 \frac{1}{2}$  mm, width 3 to 4 mm.

Type locality. — « Prom. bon. sp. ». Type probably in Museum Berlin.

Distribution. — Cape Peninsula. — Cape Town (S.A.M.); Constantia (S.A.M.); Strandfontein near Cape Town (T.M.).

33. Pronotum narrower than elytra, broadest distinctly behind middle, with the sides rather strongly sinuate in front of posterior angles. Second, fourth and sixth intervals on elytra with strong to fine costa, the latter usually with continuous and smooth crest. Abdomen with fine to moderately coarse punctation, the punctures never foveolate nor rugosely confluent, with their diameter only slightly or not larger than that of punctures on posterior femora. In the ♂ the anterior tarsi strongly dilated, the second and third segments considerably broader than the penultimate segment of antennæ ..... 34
- Pronotum, at least in the ♂, not narrower than elytra, broadest at about middle, with the sides either simply rounded and narrowed towards base or the posterior angles briefly and rectangularly demarcated. Second, fourth and sixth intervals on elytra with only rudimentary traces of carinulae or rows of granules. Abdomen with very coarse, subfoveate and often rugosely confluent punctation; the diameter of punctures considerably larger than that of punctures on posterior femora. In the ♂ the anterior tarsi weakly dilated, the second and third segments scarcely broader than the penultimate segment of antennæ.

[**Zadenos (Euzadenos) mulsanti** n. nom.]

(Pl. XXX, fig. 1; Fig. 199.)

\*1854 a, *Eurynotus (Solenopistoma) acutus* MULSANT & REY, pp. 173, 175. — 1854 b, MULSANT & REY, p. 31 (nec *acutus* WIEDEMANN).

Original description. — « Long. 9,5 mm, larg. 3,9 mm — Corps oblong; presque plan; d'un noir mat. Tête rugueusement et assez grossièrement ponctuée; marquée sur la suture frontale, d'un sillon en demi-hexagone; transversalement sillonnée après les yeux. Antennes à peine aussi longuement prolongées que les trois-quarts des côtés du prothorax; d'un rouge brun ou brunâtre; à deuxième article une fois au moins plus long que le cinquième: les sixième et septième, presque filiformes, faiblement obconiques, plus longs que larges: les huitième à dixième plus larges que longs: les huitième et neuvième, moniliformes: le dixième cupiforme: le onzième plus large que long. Prothorax arqué sur les côtés, offrant ordinairement vers les deux-tiers ou un peu moins sa plus grande largeur, plus faiblement rétrécie ensuite; presque en ligne droite ou à peine arqué en arrière sur les trois-cinquièmes médiales de la base, avec les

angles postérieurs prolongés en espèce de dent; faiblement convexe sur les trois-cinquièmes médiaires de sa largeur, et comme largement en gouttière entre cette partie discale et les bords latéraux qui sont relevés et à peine rebordés; un peu réticuleusement ponctué. Ecusson transverse; en triangle ou en arc dirigé en arrière; une fois au moins plus large que long. Elytres munies d'une petite dent dirigée de côté à l'angle huméral; faiblement élargies en ligne courbe jusqu'à la moitié ou un peu moins, rétrécies ensuite et d'une manière sensiblement sinuée avant l'extrémité, qui est tronquée; presque planes ou très faiblement convexes; chargées en dessus (y comprises les suturale et marginale) de cinq lames ou arêtes comprimées, très étroites et unies sur leur tranche: la première ou suturale, commençant à diverger en devant à partir du cinquième antérieur, enclosant ainsi avec sa pareille l'écusson, lequel est suivi d'une très-courte carène postscutellaire: la quatrième aboutissant à l'angle sutural en se courbant faiblement en dehors: la deuxième ou juxta-suturale, liée à son extrémité à la quatrième, qui se prolonge jusqu'à l'angle sutural: la troisième, à peine prolongée au-delà des quatre-cinquièmes; offrant, entre les quatrième et cinquième carènes, une tranche plus faible, à peine prolongée jusqu'à la moitié. Intervalles marqués d'une double rangée de points liés par de fortes rides transverses. Dessous du corps entièrement marqué de gros points: ceux de l'antépectus, réticuleux ou un peu unis en sillons. Prosternum rayé de trois stries non prolongées jusqu'à l'extrémité. Pieds bruns; ponctués, un peu râpeux. Cuisses antérieures un peu plus grosses. ♂ Cuisses antérieures et postérieures, ciliées en dessous, ainsi que toutes les jambes: les cuisses postérieures et les jambes de devant et de derrière plus longuement. Trois premiers articles des tarses antérieurs, garnis de brosses en dessous: les deuxième et troisième dilatés: les mêmes articles des tarses intermédiaires à peine plus larges que les autres. ♀ Cuisses et jambes glabres en dessous. Deuxième et troisième articles des tarses antérieurs à peine plus larges que les autres.»

Remarks. — This species, which MULSANT & REY erroneously referred to WIEDEMANN's *acutus*, agrees with the latter in the peculiar character of the almost incostate second, fourth and sixth intervals on elytra, but differs strongly by the following particulars. The body is of larger size. The antennæ are considerably shorter and less strongly accrescent towards apex. The eyes are not prominent. The pronotum of very similar shape, with identical, rather strong and broad submarginal depression and bi-sinuate base, but the greatest width is situated at about middle, and the dense sculpture is slightly resolved to longitudinally confluent, and not subgranular, punctures on disc. The elytra are distinctly more elongate, subparallel in the

♂ and only weakly rounded laterally in the ♀; the three outer intervals, as well as the sutural, third and fifth intervals are very strongly costate, whereas the even inner intervals are almost plane, with only slight traces of longitudinal rows of granules or carinulæ; the apical construction of costæ is similar to that in *acutus*, but the apex of the third costa is constantly coalescent with the seventh costa. The primary rows are generally composed of very coarse, transverse punctures, arranged in double rows between the sharp odd inner

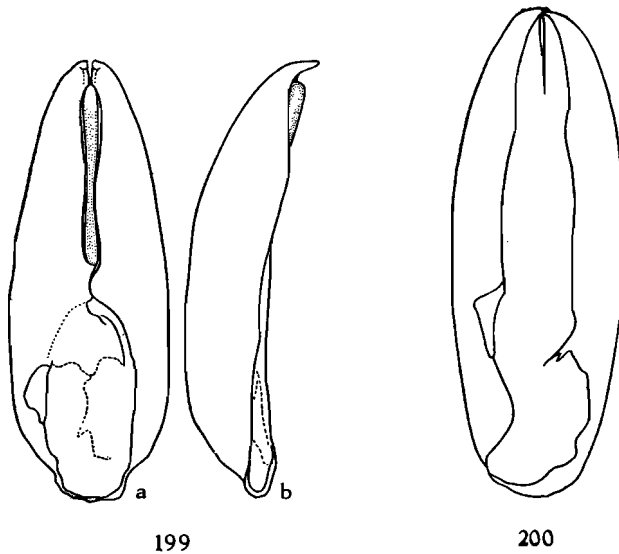

FIG. 199. — *Ædeagus* of *Zadenos (Euzadenos) mulsanti* n. sp. (a: ventral surface; b: lateral view, with the ventral surface at right). — FIG. 200. — The dissected and emptied *ædeagal tegmen* of *Zadenos (s. str.) longipalpus* (WIEDEMANN).

costæ; sometimes these punctures are less conspicuous, when they are badly demarcated from the dense and granular sculpture of intervals. Punctuation on abdomen much denser and coarser than in *acutus*. Upper surface of tibiæ with much more concentrated, rugose and opaque sculpture. In the ♂ the anterior tarsi moderately dilated, as in *acutus*; the underside of anterior tibiæ with elongately pilose, median excavation; the underside of posterior tibiæ and femora with a dense brush of rather long, testaceous bristles.

*Ædeagus* (fig. 199). — Apical portion narrowing in a straight line towards apex; parameres strongly divided, with the apices pointed and sharply bent ventrad. Ventral groove strongly constricted by the broad inflexed alæ, but penis exposed. Penis narrow, with weakly dilated, spoon-shaped apical orifice; lacinia strongly sclerotized, curved inwards, slender, shorter than penis.

Dimensions. — Length  $8 \frac{3}{4}$  to  $10 \frac{1}{2}$  mm, width  $3 \frac{1}{2}$  to  $4 \frac{1}{2}$  mm.

Type locality. — «Cap de Bonne Espérance», type probably in Museum Paris.

Distribution. — Southern part of the South-western Cape Province. — Houw Hoek (S.A.M.); Rivier Zonder End (S.A.M.); Bredasdorp (S.A.M.); Hermanus (S.A.M.); Swellendam (S.A.M.); Palmiet Rivier (S.A.M.); Rondebosch (S.A.M.); Ashton (S.A.M.); Mossel Bay (S.A.M.).

34. Primary rows of elytra with very coarse punctures; the latter considerably coarser than the discal punctation on pronotum, their diameter broader than the width of secondary costæ, almost occupying the entire intervening space between secondary costæ, often with transversely raised, subrugose margins; the odd inner costæ always strongly elevate, much more strongly raised than the alternating even inner costulæ which, in one case, are absent on fourth and sixth intervals ..... 35
- Primary rows of elytra with very fine to moderately strong punctures; the latter about as large as the diameter of the discal punctation on pronotum, the width of the diameter of secondary costæ or narrower, being situated on midline of the intervening spaces between secondary costæ and well separated from the latter on each side; the punctures always flat, without forming transversely ridged margins; the alternating even inner costæ variable, sometimes almost as strongly raised as the odd costæ, sometimes much weaker and finer, but always well indicated.

[**Zadenos (Euzadenos) costifer** n. sp.]

(Pl. XXX, fig. 2; Figs. 201, 202.)

Closely related to *Z. riversdalensis*, but with all the main characters of the *acutus - mulsanti* group. Head above with dense, strong punctures; eyes not prominent, their outlines continuous with the subparallel contours of genæ. Mentum fig. 177a. Antennæ slender; the preapical segment roundish to slightly transverse. Pronotum uniformly covered with very dense, rugose, partially confluent punctures, and with narrow, weak submarginal depression. Elytra dull, with all the intervals shiny and variously costate; the apical construction of costæ similar to that in *mulsanti*; humeral angle dentiform and prominent. Punctation on abdomen rather fine, concentrated on anal sternite. Upper surface of intermediate and posterior tibiæ dull, with dense to rugosely confluent sculpture. In the ♂ the anterior tarsi strongly dilated, the second and third segments transverse and much broader than the penultimate segment of antennæ; with a more or less developed fringe of hairs on underside of anterior and posterior tibiæ and posterior femora; the shape of intermediate and posterior tibiæ variable, straight to slightly curved.



Ædeagus (figs. 201, 202). — Similar to *Z. mulsanti*; the penis not spoon-shaped, but subparallel also apically and the lacinia not shorter than penis

Dimensions. — Length  $8\frac{1}{2}$  to  $10\frac{1}{4}$  mm, width  $4\frac{1}{4}$  to  $4\frac{3}{4}$  mm.

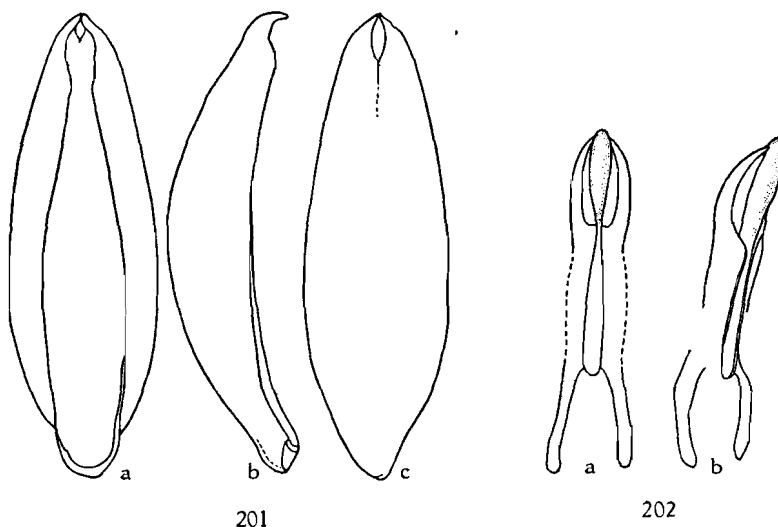

FIG. 201. — The dissected and emptied aedeagal tegmen of *Zadenos (Euzadenos) costifer* n. sp. (a : ventral surface; b : lateral view, with the ventral surface at right; c : dorsal surface). — FIG. 202. — The extracted penis plus lacinia of *Zadenos (Euzadenos) costifer* n. sp (a : outer surface; b : diagonal view).

Subspecies : —

a) *costifer* s. str. — The costæ on inner even intervals of elytra continuous, not abbreviated posteriorly, not much finer and weaker than the alternating odd costæ; each elytron therefore discally with the six inner primary rows clearly divided into six sections by the costæ on intervening secondary intervals.

Distribution. — Central and western part of the Southern Cape Province. — Bredasdorp, H. FRY (1♂, 2♀♀, types S.A.M.); Mossel Bay, VII.1886 (1♂, S.A.M.); same locality, 1913, BRO. POWER (1♂, S.A.M.); George District, VIII.1931, C. THORNE (1♂, 2♀♀, S.A.M.); Laingsburg, F. W. PURCELL (1♀, S.A.M.).

b) *intercostulatus* n. subsp. — The costæ on inner even intervals of elytra very fine, often interrupted, abbreviated posteriorly, much finer and weaker than the alternating odd costæ; each elytron discally appearing as if divided into three sections only, with each section composed of two primary rows.

Remarks. — On account of the similar development of elytral costæ, this form slightly resembles *Z. mulsanti*, from which it is readily distinguished by the fine punctation of primary rows on elytra and on abdomen, the broad elytra, the different shape of pronotum, and the less dense, not rugosely confluent sculpture on upper surface of intermediate and posterior tibiæ.

Distribution. — Southern part of the South-western Cape Province. — Rivier Zonder End, Oudebosch, 1,500 ft., XI to XII.1928, K. H. BARNARD (2♀♀, holotype S.A.M.).

35. Antennæ slender; the ninth segment distinctly longer than broad, the tenth segment roundish to slightly transverse. The even inner costæ on elytra fine, but readily visible on disc. Lateral carina of pronotum sharp and fine. The upper surface of anterior tibiæ gradually dilated behind middle, thence slightly narrowed towards apex, edged only on apical third.

[*Zadenos (Euzadenos) sculptus* n. sp.]

On account of the fine, even inner costæ on elytra very similar to *Z. mulsanti*, but the pronotum broadest behind middle and also in the ♂ narrower than elytra, the even inner costæ on elytra fine but well marked, the punctation on abdomen much finer, and the anterior tarsi strongly dilated in the ♂. In this sex the underside of anterior and posterior tibiæ, as well as that of anterior and posterior femora with a more or less developed fringe of hairs.

Ædeagus. — Similar to *costifer*, but the inflexed alæ very broad and subparallel on posterior three-quarters, more strongly constricting the narrow ventral groove; penis similar, the lacinia, however, with the apices bent into a direction which runs subparallel with penis.

Dimensions. — Length  $8\frac{3}{4}$  to  $9\frac{3}{4}$  mm, width 4 to  $4\frac{1}{2}$  mm.

Distribution. — Central part of the Southern Cape Province. — George, H. BRAUNS (1♂, holotype T.M.); Robinson's Pass, X.1922, H. BRAUNS (1♂, T.M.); Mossel Bay, VII.1886 (1♂, S.A.M.); Rivier Zonder End, Oudebosch, 1,500 ft., XI-XII.1928, K. H. BARNARD (1♂, S.A.M.).

- Antennæ stout, strongly accrescent towards the apex; both the ninth and tenth segments strongly transverse. The even inner costæ on elytra rudimentary, very fine, weakly indicated on second interval, practically absent on the fourth and sixth intervals. Lateral carina of pronotum thick and obtuse. The upper surface of anterior tibiæ gradually dilated in a straight line to apex, not constricted in front of the latter, with the rather sharp and prolonged edge almost reaching the base of tibia.

[**Zadenos (Euzadenos) crassicornis** n. sp.]

In the sculpture of elytra almost identical with *Z. mulsanti*, but the pronotum strongly sinuate in front of posterior angles and broadest decidedly behind middle, the antennæ stout and the punctures on abdomen rather coarse, but much less concentrated and not foveate. Closely related also to *Z. sculptus*, from which it is distinguished by the larger size of body, the much more coarsely sculptured pronotum which is broadest quite behind middle and exhibits strongly produced posterior angles, the rudimentary even inner costulæ on elytra and the coarser, less clearly marked and transversely rugose punctures of primary rows. ♂ unknown.

Dimensions. — Length 10 ½ mm, width 4 ¾ mm.

Distribution. — Southern part of the South-western Cape Province. — Riversdale, XII.1932, T. G. JOUBERT (1♀, holotype T.M.).

36. Elytra very opaque, with serrate-denticulate outer contours; at least the outer costæ serrate to denticulate, the sutural interval sharply costate, the inner even intervals with well separated round tubercles or granules at least posteriorly; intervals with barely indicated punctures. The proximal sternites of abdomen with very coarse, subfoveate and rugosely confluent punctures which are much coarser than the punctures on pseudopleura; anal sternite strongly convex or bunched up on basal half. Femora with a few long, erect bristles. In the ♂ the anterior tarsi not or weakly dilated, only inconspicuously to slightly broader than in the ♀, the underside of intermediate and posterior tibiæ and of posterior femora with long and dense brush of yellowish hairs.

**ZADENOS** subg. **SERRIDENOS** nov. .... 37

Type species: *Zadenos (Serridenos) solenopistoma* n. sp.

- Elytra distinctly shiny, with smooth outer contours; all costæ with smooth crest which is sometimes minutely crenulate on posterior portion of outer costæ; the sutural interval slightly tectiform to obtusely costate, the inner even intervals with fine, continuous costæ which are only slightly less raised than the alternating odd costæ; intervals with conspicuous, very dense to rugose punctation. The proximal sternites of abdomen with fine, very dense, slightly confluent punctures which are scarcely stronger than punctures on pseudopleura; anal sternite uniformly flat. Femora with the usual, fine, microscopical pubescence, but without long bristles. In the ♂ the anterior tarsi rather strongly dilated, considerably broader than in the ♀, the underside of femora and tibiæ with variously developed, fine, subtomentose stripes of short hairs.

**ZADENOS** subg. **ZADENOS** s. str.

Monotypical.

[**Zadenos** (s. str.) **longipalpus** (WIEDEMANN).]

(Pl. XXX. fig. 3; Figs. 200, 203, 204.)

\*1823, *Opatrum longipalpe* WIEDEMANN, p. 32.1840, *Pedinus (Zadenos) longipalpus* LAPORTE DE CASTELNAU, p. 210.1933-1942, *Eurynotus longipalpus* GEBIEN, p. 414, n° 5541.

Original description. — « Rubido-fuscum; thorace cicatricoso, elytris porcatis, interstitiis punctatis. Longit. lin. 5. — Obwohl die Kinnladentaster weit über den Kopf hinausragen, muss diese Art doch unbezweifelt zur Gattung *Opatrum* gezählt werden. Die Farbe der ganzen oberen Fläche ist ein rötliches braun, welches an der untern Fläche an den Fusswurzeln, ja schon an den Fühlern stark mit gelb gemischt ist. Lefze äusserst wenig ausgerandet, Kopfschild aber sehr stark, dieser vom Kopfe selbst durch einen randförmigen oder nach vorn concav gebogenen deutlichen Streif geschieden, beide ziemlich grobnarbig. Hasschild breit viereckig, Seitenränder breit, aber wenig aufgebogen, etwas uneben convex, vorn mehr als hinten convergierend, Vorderrand ausgeschnitten, in der Mitte mit einer kleinen Vertiefung. Wurzelrand sehr flach geschweift, Oberfläche narbig, in der Mitte kaum die Spur einer Längsfurche. Flügeldecken jede mit sieben scharf erhabenen Streifen, die äussersten am schärfsten, Zwischenräume flach rinnenförmig und deutlich punctiert, so dass neben einer Hauptreihe von Punkten noch mehrere kleinere Punkte stehen. Untere Fläche und Beine deutlich punctiert, die Punkte durch Längsstreifen verbunden. »

Remarks. — *Z. longipalpus* is very well characterized by the sulcate upper surface of intermediate and posterior tibiae, the strongly developed and prolonged genal canthus and the presence of a fine costa on the tenth interval of the reflected lateral portion of elytra. The head is large, densely and rugosely punctured on vertex. Lateral portions of epistome not demarcated from genæ. Clypeal impressions oblique. Genæ large, strongly produced beyond contours of eyes and narrowed in a straight line towards the latter, with the canthus constricting the two anterior thirds of eye and leaving exposed only one to two transverse rows of corneal facets posteriorly. Mentum (fig. 177b) depressed on apical half. Maxillary palpi long, with slender and elongate first segment and securiform apical segment. Antennæ slender, distinctly compressed and accrescent towards apex; the two penultimate segments transverse. Pronotum transverse, uniformly covered with an extremely dense, longitudinally confluent and rugose sculpture, with strong, subsulcate and rather broad submarginal

depression, and with the sides equally rounded and narrowed towards anterior margin, as well as towards base, rarely very shallowly sinuate in front of posterior angles. Prosternal apophysis horizontally produced. Elytra scarcely ( $\sigma$ ) to slightly ( $\varphi$ ) broader than pronotum, with almost subparallel ( $\sigma$ ) to slightly rounded ( $\varphi$ ) sides. Humeral angle minutely demarcated. Apical construction of costæ

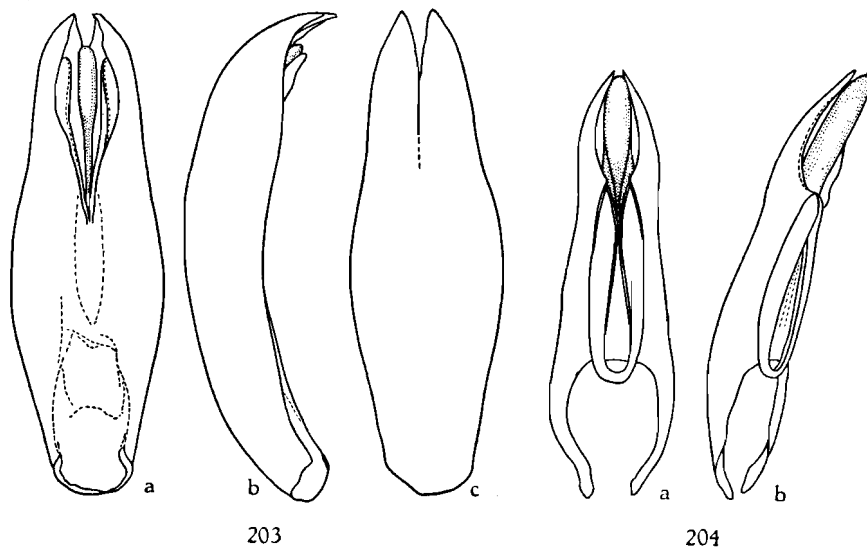

FIG. 203. — *Ædeagus* of *Zadenos* (s. str.) *longipalpus* (WIEDEMANN) (a : ventral surface; b : lateral view, with the ventral surface at right; c : dorsal surface). — FIG. 204. — The extracted penis plus lacinia of *Zadenos* (s. str.) *longipalpus* (WIEDEMANN) (a : outer surface; b : diagonal view).

very similar to that in *Z. bohemani*, but often the eighth costa prolonged and then ending only at very short distance from apical angle of suture.

*Ædeagus* (figs. 200, 203, 204). — Broad and short, moderately converging distally. Parameres deeply divided, with the apices strongly gaping, sharply pointed and abruptly bent ventrad. Ventral groove very broad, with distally reduced inflexed alae and entirely exposed penis and lacinia; penis thin, subparallel; lacinia compressed and foliaceous proximally, only slightly thinner than penis, with the apical portion curved into a position which is subparallel with penis.

Dimensions. — Length  $9\frac{1}{2}$  to 11 mm, width  $3\frac{3}{4}$  to 5 mm.

Type locality. — « Prom. bon. sp. ». Type probably in Museum Berlin.

**Distribution.** — Central and eastern part of the Southern Cape Province. — Port Elizabeth (S.A.M.); Grahamstown (Rh.U.); Port Alfred, Kowie River (S.A.M.).

37. Elytra with the seventh, eighth and ninth costæ sharply serrate-denticulate; the three odd inner intervals with strongly raised costæ which are smooth to finely crenulate on basal half, denticulate on apical half; the three even inner intervals with a longitudinal row of widely separated, roundish tubercles; the tenth interval on reflected lateral portion plane, not costate, but coarsely and irregularly punctured. Pronotum scarcely narrowed posteriorly, there with practically subparallel sides. In the ♂ the anterior tarsi inconspicuously broader than in the ♀.

[**Zadenos (Serridenos) solenopistoma** n. sp.]

(Pl. XXX, fig. 4; Figs. 177 c, 187, 205 to 207.)

This species is remarkable by the peculiar sculpture of elytra, strikingly similar to the *Oncotin Eurynotus (Solenopistoma) denticosta* MULSANT & REY (fig. 206). — Head (fig. 187) very similar to *Z. longipalpus*, but the sculpture on upper surface very coarse and rugose, the genæ still more strongly projecting beyond eyes and the supra-orbital edges subcarinate. The underside of head bare, with dense, very coarse and subfoveate punctation. Mentum fig. 177c. Antennæ as in *longipalpus*. Pronotum broadest at about middle, one and a half to one and two thirds times as broad as long, only slightly narrower than elytra, covered with an extremely dense, rugose sculpture, becoming very coarse, longitudinally confluent and substriolate on disc. Anterior emargination deep, with produced and sharp anterior angles. Sides moderately rounded, in front of posterior angles from subparallel to weakly narrowed; submarginal depression broad and strong. Base shallowly bi-sinuate, with rectangular to faintly obtuse posterior angles. Prosternum together with episternum very coarsely and densely punctured, the lateral area of the latter obsoletely and transversely wrinkled; intercoxal apophysis horizontally produced and pointed apically. Elytra with subparallel to weakly rounded sides, minutely prominent and sharp humeral angles and carinate base. Primary rows with rather coarse, but shallow and often transversely rugose punctures. Intervals without discernible punctation, with very strongly raised costæ on outer and odd inner intervals, the sutural interval included; on apical declivity the seventh costa prolonged to the sutural angle of apex and there in contact with the third costa, the eighth costa abbreviated and ending at considerable distance from apex. Underside of hind body, the legs included, with very coarse and dense punctation; the punctures on anal sternite much finer than those on proximal sternites.

Ædeagus (fig. 207). — The apical portion sharply demarcated from basal one by a lateral constriction and a shallow, transverse impression on dorsal surface. Ventral groove very broad, restricting the inflexed alæ to narrow lateral margins and leaving entirely

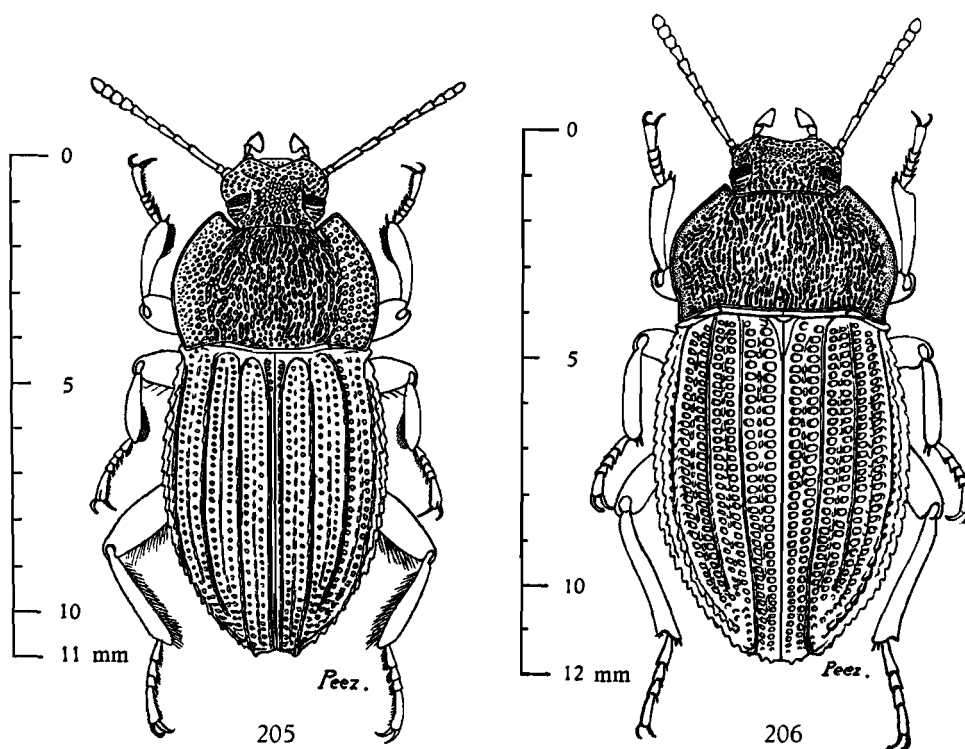

FIG. 205. — *Zadenos (Serridenos) solenopistoma* n. sp. (*Litoborini*).

FIG. 206. — *Eurynotus (Solenopistoma) denticosta* MULSANT & REY (*Oncotini*). Both species, the representatives of two different tribes, occur in the same area, demonstrating a striking case of converging parallel development of shape and sculpture of body.

exposed the penis and lacinia. Parameres gradually narrowed towards apex, deeply divided and gaping on distal portion, with sharply pointed, but weakly curved apices. Penis with minutely bifid apex, very strongly dilated towards base, there forming a peculiar, roundish and shallowly concave sclerite which is separated from the distal portion by a strongly raised, transverse ridge. Lacinia large, almost the length of penis, complanate and foliaceous, with very fine, sharply pointed, hook-like apices which are subangularly bent outwards.

Dimensions. — Length  $9\frac{1}{2}$  to  $12\frac{1}{2}$  mm, width  $4\frac{1}{4}$  to  $5\frac{3}{4}$  mm.

Distribution. — Central part of the Southern Cape Province. — Willowmore, X.1918, H. BRAUNS (18 spec., types T.M.).

- Elytra with the ninth costa serrate-denticulate, the crest of the eighth costa tuberculate and that of the seventh costa finely crenulate on anterior half, denticulate on posterior half; the three inner even intervals very similar to the alternating, inner, odd intervals, viz. provided with con-

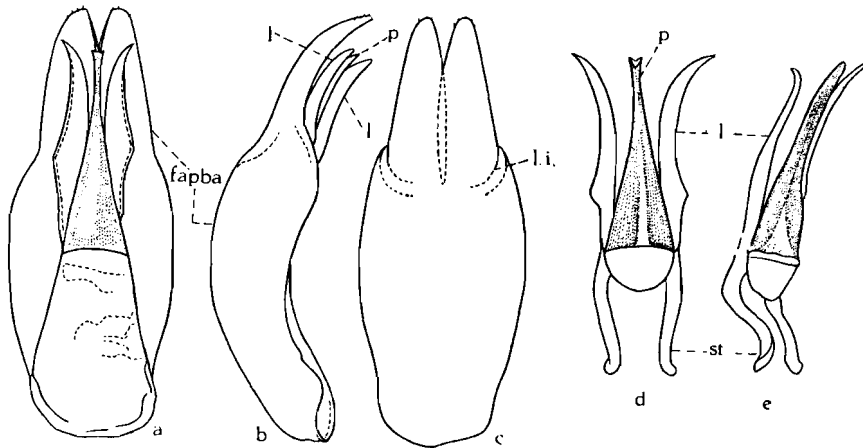

FIG. 207. — Aedeagus of *Zadenos (Serridenos) solenopistoma* n. sp. (fapba : the fused apical and basale of aedeagal tegmen; l : lacinia; l.i. : lateral impression; p : penis; st : struts of inner sclerites).

a : ventral surface; b : lateral aspect, with the ventral surface at right; c : dorsal surface; d : the extracted penis and lacinia, outer surface; e : ditto, diagonal view.

tinuous, slightly wavy to weakly crenulate costæ which are only less strongly raised than the odd costæ; the tenth interval on reflected lateral portion with extremely fine, granular but continuous carina. Pronotum almost as strongly rounded and narrowed towards the base as towards the anterior margin. In the ♂ the anterior tarsi distinctly dilated and broader than in the ♀.

[***Zadenos (Serridenos) XX-costatus*** n. sp.]

This species, the largest Southern African *Litoborin*, is closely related to *Z. solenopistoma*, but readily distinguished by the above mentioned and following characters. The sculpture on upper surface of head is denser, finer, forming a regular, extremely dense reticulation. The mandibular teeth on postgenal margin are longer and sharply pointed. The pronotum with strongly rounded sides, a much



more strongly demarcated submarginal depression, but an extremely fine lateral carina (which is rather thick and shiny in *solenopistoma*); its sculpture is much finer, but extremely dense, forming a kind of fine reticulation, similar to that on head. The elytra are similar to *solenopistoma*, but the lateral outlines are less strongly serrate and on apical declivity it is not the seventh costa, which is prolonged, but the third costa; the latter angularly bent towards suture in front of apex and coalescent with the sutural angle apically; the apex of the seventh costa not in contact with the third costa. In the ♂ the legs as in *solenopistoma*, but the anterior tarsi with distinctly dilated, transverse second and third segments. Ædeagus almost identical with that of *solenopistoma*.

**Dimensions.** — Length  $12 \frac{1}{4}$  to  $13 \frac{1}{4}$  mm, width  $4 \frac{3}{4}$  to  $5 \frac{1}{2}$  mm.

**Distribution.** — Eastern-central part of the Southern Cape Province. — Farm Resolution, near Fort Brown, Albany District, VI.1928, A. WALTON (1 ♂ ♀, types T.M.).

- 38.** Genal canthus completely dividing eyes and in contact with tempora ..... **39**
- Genal canthus very strongly constricting eyes, but its apex separated from tempora, leaving exposed at least one transverse row of corneal facets ..... **41**
- 39.** Upper surface of head plane; supra-orbital edge weak; the outer contours of genæ and tempora forming a continuous, straight line; lateral outlines of epistome straight. Pronotum covered uniformly with a fine, very dense reticulation. Elytral costæ smooth. Anterior tibiæ rather strongly dilated towards apex, with the latter about as broad as the length of unguis segment of anterior tarsi ..... **40**
- Upper surface of head with deeply impressed epistomal sulcus, a short, cariniform elevation along midline of vertex and strongly raised supra-orbital edges; the outer contours of genæ and tempora interrupted by a minute incision; lateral contours of epistome sinuate. Pronotum with strongly raised, sharp, irregular rugosities on disc. Elytral costæ serrate-denticulate. Anterior tibiæ faintly dilated towards apex, with the latter considerably narrower than the length of unguis segment of anterior tarsi.

[*Minorus sculpticeps* n. sp.]

(Pl. XXVII, fig. 2; Figs. 188, 208 to 210) (1).

Reddish brown to black, very opaque, as all the other species of the *rugicollis* group. Head (fig. 188) above densely rugose. The epistomal sulcus very deep, of variable shape, sometimes running across the entire width of frons and reaching the eyes; the median carinula on vertex more or less strongly developed, sometimes

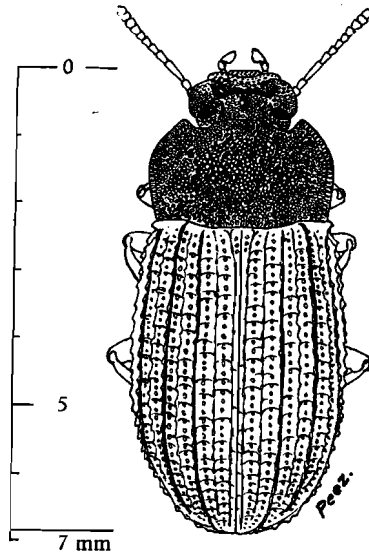
FIG. 208. — *Minorus sculpticeps* n. sp.

produced anteriorly and forming a triangular elevation, the anterior margin of which is in contact with the anteriorly curved supra-orbital edges; sometimes also divided anteriorly and there with a transverse ridge on each side, reaching the supra-orbital edge. Pronotum in shape similar to *rugicollis*, but broadest in front of middle, the posterior half of sides subparallel or very slightly narrowed in a straight line towards base, the submarginal depression stronger and the discal convexity weak. Elytra more elongate, subparallel, distinctly broader than pronotum, with carinate base and serrate outlines. Primary rows distinct; all costæ serrate-denticulate, in dorsal view appearing as if tuberculate; on apical declivity

(1) Instead of the erroneous caption to fig. 2 on Plate XXVII [*Zadenos* (*Euzadenos*) *externus* n. sp.] read correctly: *Minorus sculpticeps* n. sp.

the third, seventh and sutural costæ coalescent apically; the eighth costa abbreviate; the tenth costula on reflected lateral portion very fine. Pseudopleura complete, but very narrow around anal sternite. Abdomen sparsely punctured. Legs and antennæ more slender than in *rugicollis*. The upper surface of all tibiæ narrowly sulcate, with sharp lateral edges; femora densely punctured.

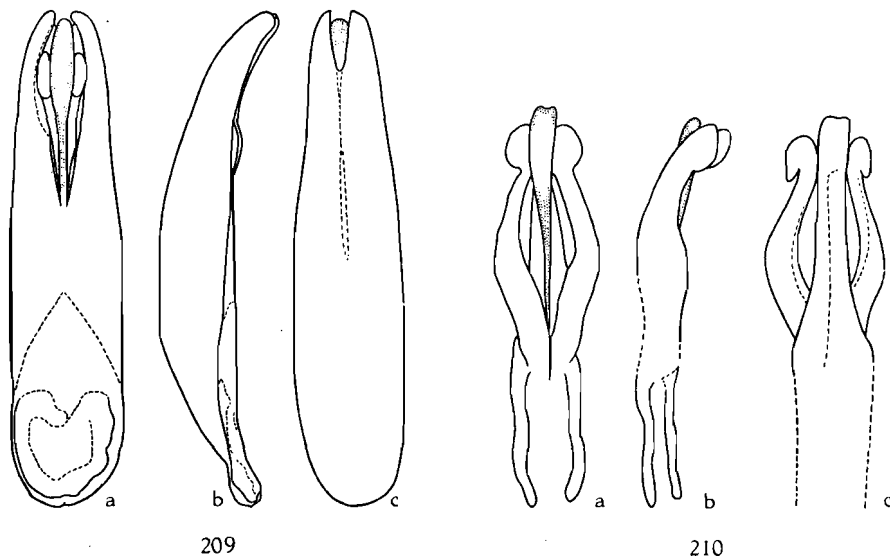

FIG. 209. — *Ædeagus* of *Minorus sculpticeps* n. sp. (a : ventral surface; b : lateral view, with the ventral surface at right; c : dorsal surface). — FIG. 210. — The extracted penis plus lacinia of the *ædeagus* of *Minorus sculpticeps* n. sp. (a : outer surface; b : lateral view; c : inner surface).

*Ædeagus* (figs. 209, 210). — Slender and small; sides of apical portion gradually narrowed towards apex. Parameres deeply divided, slender, with scarcely curved, slightly gaping, rather obtuse apices. Ventral groove broad, leaving exposed the penis and a small portion of lacinia; penis subparallel; lacinia of peculiar shape, as long as penis, «S»-shaped and strongly curved, with dilated and rounded apices.

*Dimensions*. — Length  $6 \frac{3}{4}$  to 8 mm, width  $3 \frac{1}{4}$  to  $3 \frac{3}{4}$  mm.

*Distribution*. — Western part of the North-western Cape Province. — Garies, XI.1949, C. KOCH (3 spec., types T.M.); 15 m W of Garies, XI.1948, Univ. California — Transv. Mus. Exped. (1 spec., M.C.A.); Spectakel, XI.1885, L. PÉRINGUEY (5 spec., S.A.M.); Kleinzee, III.1935, Mus. Staff (30 spec., S.A.M.); Kamieskroon, IX.1930, Mus. Staff (4 spec., S.A.M.).

40. Genæ moderately narrowed towards eyes, forming a widely obtuse angle with the lateral portions of epistome. Antennæ distinctly longer than the head is broad, with slender segments, of which only the three penultimate segments are transverse. Pronotum less broad, about two-thirds broader than long, with strongly produced and sharp anterior angles. Elytra considerably longer than broad; the seventh costa usually separated from the third costa apically; all costæ less strongly raised and the sculpture on primary rows and intervals finer. Abdomen with dense and rather fine, somewhat asperous punctation.

[**Minorus rugicollis** (MULSANT & REY).]

(Pl. XXXI, fig. 2; Fig. 177 d.)

\*1854 a, *Eurynotus (Minorus) rugicollis* MULSANT & REY, p. 185. — 1854 b, MULSANT & REY, p. 41.

1870, *Eurynotus rugicollis* GEMMINGER & DE HAROLD, p. 1914. — 1910 b, GEBIEN, p. 276. — 1938-1924, GEBIEN, p. 414, n° 5546.

Original description. — « Long. 6,7 mm, lat. 3 mm — Corps ovalaire ou ovale oblong; assez faiblement convexe; brun ou d'un noir-brun mat. Tête ponctuée d'une manière finement rugueuse ou réticuleuse. Épistome et palpes d'un rouge-brun ou brunâtre. Antennes de même couleur ou à peu près; à peine prolongées au-delà des trois-cinquièmes des côtés du prothorax; à troisième article près d'une fois plus grand que le cinquième : les trois derniers renflés en forme de massue oblongue. Prothorax élargi en ligne courbe jusqu'aux angles postérieurs; bisinué à la base, avec le tiers médiaire de celle-ci, presque en ligne droite et un peu plus prolongée en arrière que les angles; assez faiblement ou très-médiocrement convexe, avec ses bords sensiblement relevés et formant par là une gouttière peu profonde à leur côté interne; réticuleux ou marqué de gros points séparés par des intervalles tranchants. Ecusson transverse. Elytres à peu près aussi larges ou à peine plus larges en devant que le prothorax à ses angles postérieurs; un peu obliquement coupées dans la moitié externe de leur base; non munies d'une petite dent dirigée en dehors à l'angle huméral; faiblement élargies à partir de l'angle huméral jusqu'à la moitié, en ogive étroite postérieurement; assez faiblement ou très-médiocrement convexes; à dix sillons : huit visibles en dessus, profonds, marqués chacun dans le fond d'une rangée longitudinale de saillies transverses faisant paraître ces sillons ridés transversalement; notés en outre d'une rangée latérale de petits points : les neuvième et dixième sillons plans ou à peine convexes, visibles seulement en dessus. Intervalles des sillons de la partie supérieure étroits, en forme de tranche : le sutural divergeant en devant pour enclore l'écusson : le troisième prolongé jusqu'à l'angle sutural, en s'incurvant vers celui-ci : le septième, non lié postérieure-

ment au troisième : ces deux sillons enclosant les quatrième à sixième : le cinquième plus long que les deux autres. Dessous du corps brun ou d'un noir-brun; marqué de points grossiers et un peu râpeux sur les parties latérales et antérieures de l'antépectus; marqué de points ronds et un peu moins gros sur le ventre. Prosternum rugueusement ponctué; sans traces de sillon. Pieds d'un rouge-brun; tibias antérieurs un peu dilatés, plans râpeux, en dessous, (au moins chez la ♀, la seule que nous ayons vue). ♀ Tibias glabres en dessous. Tarses antérieurs non dilatés. »

Remarks. — *M. rugicollis* appears to be very variable as to the elytral sculpture. The primary rows are often conspicuous and the granular punctation of intervals distinct, but there are many specimens, in which the punctures of primary rows become more and more obsolescent, often transversely rugose and not demarcated from the irregular and granular sculpture on intervals. The apex of the seventh costa is usually separated from that of third costa, but sometimes, and particularly in small specimens, both are in contact with each other. The tenth costa on reflected lateral portion is sharp and well developed. The pseudopleura are complete, reaching the extreme apex of elytra. The upper surface of all tibiae is sulcate, with rather sharp edges on sides. Mentum fig. 177d.

Ædeagus. — Of peculiar shape. Apical portion of tegmen strongly narrowed towards apex, but abruptly constricted at the elongate, thin, subparallel and spiniform, parameral apical third. Parameres deeply and elongately divided, slightly gaping, with very long, entirely straight and narrowly rounded apices. Ventral groove very narrow, strongly constricted by the broadened but compressed inflexed alæ, leaving exposed just a narrow median portion of penis; the latter peculiar, strongly dilated proximally, but very thin, entirely compressed and laminiform on apical third, there carinate ventrally and with the rounded apex forming a sharply pointed hook, directed proximad and well visible in lateral aspect; lacinia considerably shorter than penis, much narrower than the proximally dilated portion of the latter, compressed, moderately curved and with rounded apices.

Dimensions. — Length  $5 \frac{1}{4}$  to 8 mm, width  $2 \frac{1}{2}$  to  $3 \frac{3}{4}$  mm.

Type locality. — «Le Cap de Bonne Espérance». Type probably in Museum Lyon or Paris (coll. DEYROLLE).

Distribution. — Central part of the Southern Cape Province. — Willowmore (T.M., M.C.A.); gorge 5 m. W of Willowmore (T.M., M.C.A.); 40 m. W of Willowmore (T.M., M.C.A.); btwn. Klipplaat and Miller (T.M.); Aberdeen (T.M.); Meirings Poort (S.A.M.); Algoa Bay (T.M.).

- Genæ strongly narrowed towards eyes, forming an almost right angle with the lateral portions of epistome. Antennæ only as long as the head is broad, with very short segments, of which the five penultimate segments are transverse. Pronotum strongly transverse, about twice as broad as long, with moderately produced and less sharp anterior angles. Elytra only a little longer than broad; the seventh costa always

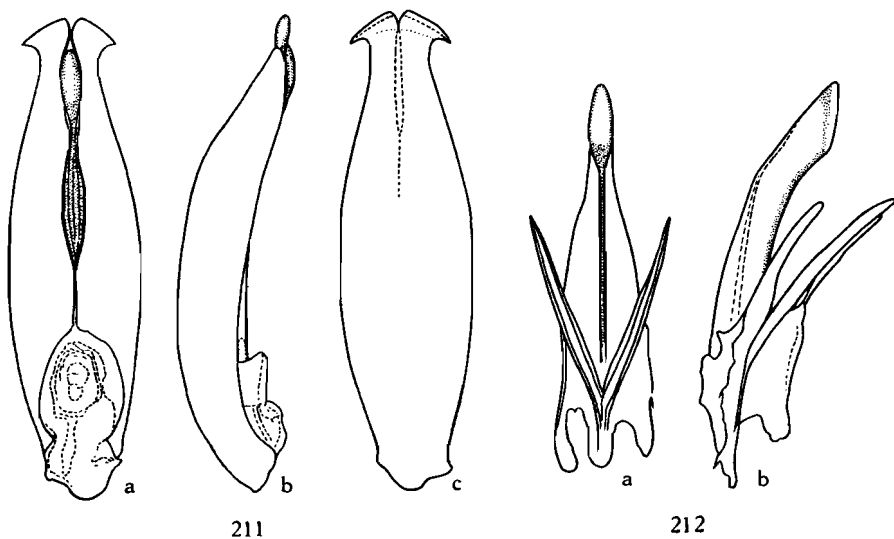

FIG. 211. — Aedeagus of *Minorus curtus* n. sp. (a: ventral surface; b: lateral view, with the ventral surface at right; c: dorsal surface). — FIG. 212. — The extracted penis plus lacinia of the aedeagus of *Minorus curtus* n. sp. (a: outer surface; b: diagonal view).

coalescent with the third costa apically; all costæ very strongly raised and the sculpture on primary rows and intervals strong. Abdomen with coarse, flat and rather scattered punctures.

[***Minorus curtus*** n. sp.]

(Figs. 211, 212.)

Closely related to *M. rugicollis*, but specifically differing by the above mentioned characters, as well as by the formation of apices of parameres of aedeagus. Head more strongly amplexed in the prothorax than in *rugicollis*, with less deep epistomal emargination. Antennæ strikingly short; the third segment not quite twice as long as broad and only one-third longer than the second segment. Pronotum with more strongly rounded sides, in front of posterior angles

subparallel or more often distinctly rounded and narrowed; under-side of prothorax with very dense and coarse punctation. The intervals on the short elytra densely and rather sharply granulate. Tibiæ shorter, the anterior ones more strongly dilated towards apex.

**Ædeagus** (figs. 211, 212). — Strongly differentiated from *M. rugicollis*. The apical portion of tegmen with converging sides, but sinuate in front of the peculiarly shaped apex of parameres. The latter strongly divided, with the apices straight, dilated, obliquely cut, with minutely prominent, sharply dentiform lateral angles, directed dorsad and projecting beyond dorsal contours of parameres in lateral aspect. Ventral groove broader than in *rugicollis*, leaving the penis exposed; penis very strongly dilated as is the case in *rugicollis*, but the apical orifice elongately spoon-shaped and minutely dilated, strongly compressed and with obtuse angle (lateral aspect); lacinia similar to *rugicollis* but entirely straight and their apices, in ventral view, sharply pointed (rounded, however, in lateral view).

**Distribution.** — Central part of the Southern Cape Province. — Willowmore, H. BRAUNS (8 spec., types T.M.).

**Remarks.** — This species and *Z. rugicollis* occur at Willowmore, but they do not seem to live together, as the many specimens, collected by the University of California-Transvaal Museum Expedition belong all to *rugicollis*, whereas all specimens, found by the late Dr. H. BRAUNS, are *curtus*.

- 41.** The tenth interval on reflected lateral portion of elytra more or less distinctly costate ..... **42**
- The tenth interval on reflected lateral portion of elytra plane and without any trace of a costula ..... **48**
- 42.** Elytral costæ more or less distinctly serrate to denticulate, their lateral contours widely serrate at least on posterior half. The fine, uniformly reticulate sculpture on pronotal disc intermixed with scattered, fine and roundish granules ..... **43**
- Elytral costæ and lateral outlines smooth. Pronotal disc either with coarsely reticulate sculpture, or densely rugose, but without supplementary granules ..... **44**
- 43.** Antennæ stout, with transverse five penultimate segments. Pronotum with strongly produced, very sharp, almost acute anterior angles. Elytra with more strongly serrate costæ, densely sculptured intervals and badly defined to obsolescent punctures of primary rows; the lateral contours distinctly serrate from base to apex.

[*Minorus namaquanus* n. sp.]

(Pl. XXXI, fig. 3.)

On account of the serrate-denticulate elytral costæ very similar to *M. sculpticeps* and agreeing with the latter in the arrangement of costal elements of elytral sculpture. Readily recognizable by the following characters. Body shorter and broader. Head smaller, with much finer sculpture and plane upper surface, exhibiting only very shallow clypeal impressions. Genæ broadly rounded and produced beyond ocular outlines; genal canthus abbreviate posteriorly and not entirely dividing eyes. Antennæ stout and much shorter, with transverse five penultimate segments. Pronotum less transverse, more distinctly rounded laterally, with very fine, uniform reticulation, without irregular and coarse rugosities on disc, but with scattered, small, roundish granules. Anterior angles of pronotum strongly produced and very sharp. Elytra with rounded sides, distinctly broader than pronotum, with less strongly serrate costæ, immarginate base and densely, irregularly sculptured intervals. Abdomen with finer, but denser punctation. Tibiæ more slender, their upper surface not or only obsoletely sulcate.

Ædeagus. — Stout and of simple shape. The apical portion strongly narrowed towards apex. Parameres deeply divided, not gaping apically, with practically straight and obtuse, but narrowed apices, closely attached to one another. Ventral groove very narrow, reduced to a narrow slit between the dilated inflexed alæ; penis stout, subparallel, with broadly rounded, non-compressed apical orifice; lacinia slightly shorter than penis, moderately narrower than the latter, subcylindrical and strongly curved outwards.

Dimensions. — Length 6 ½ to 7 mm, width 3 to 3 ¼ mm.

Distribution. — South-western part of the North-western Cape Province. — Strandfontein, near the mouth of the Olifants River, XI.1949, C. KOCH & B. MALKIN (24 spec., types T.M.); near Klaver, XI.1948, Univ. California — Transv. Mus. Exped. (1 spec., M.C.A.).

- Antennæ slender, with only one or two transverse penultimate segments. Pronotum with moderately produced and less sharp anterior angles. Elytra with very weakly serrate costæ, only obsoletely punctured intervals, but with regularly and conspicuously punctured primary rows; the lateral contours finely and widely serrate only on posterior half.

[*Minorus gracilicornis* n. sp.]

Extremely closely related to *M. namaquanus* and agreeing with the latter in all the remaining characters, with the exception of the broader, laterally more strongly narrowed elytra which are considerably broader than the pronotum.



Dimensions. — Length  $7\frac{1}{2}$  to 8 mm, width 3 to  $3\frac{1}{2}$  mm.

Distribution. — North-western Cape Province. — Garies, VI.1930, Mus. Staff (6 spec., types S.A.M.).

44. Genæ distinctly to strongly projecting beyond ocular outlines, their lateral contours narrowed towards eyes and including with the contours of the latter a strong angle ..... 45
- Genæ not projecting beyond ocular outlines, but their lateral contours subparallel and continuous with the likewise subparallel contours of eyes plus tempora ..... 47
45. Head above with only a shallow and small clypeal impression on each side; genal-epistomal angle broadly rounded and moderately projecting beyond ocular outlines. Antennæ distinctly longer than the head is broad, stout and, as usually, gradually accrescent towards apex; at least the two penultimate segments transverse; the tenth segment not different in shape from the ninth segment and only a little broader than the latter; the apical segment longer than the preceding segment, but hardly narrower, pedunculate and loosely attached to the latter, as are all the other segments. Disc of pronotum densely and irregularly rugose. Pseudopleura abbreviated apically ..... 46
- Head above with a very deep, rather broad, straight, transverse epistomal sulcus, running across frons, but ending on both sides at a point, where usually the clypeal impression is situated. Genal-epistomal angle very strongly projecting beyond ocular outlines, forming an almost right angle. Antennæ scarcely longer than the head is broad, fine, with suddenly dilated apical and preapical segments, the latter forming a kind of club; only the preapical segment transverse and much larger than all the other segments; the apical segment closely jointed to the preapical segment, not pendunculate, about as long as the latter, but considerably narrower. Disc of pronotum with coarse, but uniform reticulation. Pseudopleura complete and reaching the extreme apex of elytra.

[*Minorus hessei* n. sp.]

A peculiar species which is easily distinguished from all the related species by the differentiated head and antennæ. Body very opaque, black, the appendages reddish brown and often the marginal portions of underside, head and pronotum paler. Head strongly transverse, densely and coarsely reticulate above. Pronotum about two-thirds broader than long, broadest at about middle, thence strongly rounded and narrowed to the sharply produced anterior angles, but straight and subparallel posteriorly. Submarginal depression of sides confined to a very narrow canaliculation along lateral carina. Base broadly bi-sinuate, with a transverse impression just in front of lateral sinuosities. Underside of prothorax

densely and coarsely punctured. Prosternal apophysis horizontally produced. Elytra exactly as broad as pronotum, with straight and subparallel sides which are broadly rounded posteriorly. Base immarginate, not broader than the pronotal base; humeral angles rectangular. All intervals sharply costate, with smooth crest, the sutural and tenth intervals included; all dorsal costæ reaching the base and coalescent with the basal carina (which, usually, is concealed by the overlapping base of pronotum); on apical declivity the third costa prolonged and in contact with the sutural angle of apex, but not always coalescent with the seventh costa; the eighth costa approximated to apex of elytra. Primary rows with coarse and regular punctures. Abdomen with coarse, very dense punctures, becoming longitudinally confluent on the basal portion of the second and third sternites. Anterior tibiæ rather strongly dilated towards apex, there about as broad as the length of the unguis segment of anterior tarsi; upper surface of tibiæ edged laterally, but only obsoletely sulcate. Tarsi slender.

*Ædeagus*. — *Ædeagal tegmen* as in *M. namaquanus*, of simple shape, but smaller and slender.

*Dimensions*. — Length  $5 \frac{3}{4}$  to  $6 \frac{1}{2}$  mm, width  $2 \frac{3}{4}$  to 3 mm.

*Distribution*. — Southern part of the South-western Cape Province. — Somerset West, III.1930, A. J. HESSE (7 spec., types S.A.M.).

*Dedication*. — Named in honour of Dr. A. J. HESSE, entomologist to the South African Museum, Cape Town.

46. Abdomen almost dull, owing to an extremely dense, coarse, rugosely confluent punctation on entire surface; punctures with rather long, adherent yellowish bristles, becoming short towards apex. Primary rows on elytra, the reflected lateral portion included, absent, but the intervals with irregular sculpture.

[*Minorus rugiventris* n. sp.]

Related to *M. jouberti*, but of smaller size, the antennæ stouter, strongly accrescent towards apex and with transverse four penultimate segments, the genæ projecting beyond ocular outlines, the pronotum coarsely rugose on disc and with very sharply produced anterior angles, the elytra subparallel, with prominent humeral angles, strong costæ, irregular punctures on reflected lateral portion and without primary rows. The abdomen pilose as in *jouberti*, but the sculpture extremely dense and rugose. Legs shorter, the anterior tibiæ slightly more strongly dilated towards apex, the tarsi considerably shorter, the basal segment of posterior tarsi shorter than the unguis segment.

Dimensions. — Length  $7 \frac{3}{4}$  mm, width  $3 \frac{1}{2}$  mm.

Distribution. — Central part of the South-western Cape Province. — Top of Skurweberg, Cold Bokkeveld, Ceres District, X.1934, M. VERSFELD (1 spec., sex not determined, holotype S.A.M.).

- Abdomen shiny, with strong, but very well separated round punctures; the latter practically bare, as the bristles are microscopically short. Primary rows on elytra, the reflected lateral portion included, well indicated; the intervals with rather scattered, fine punctures.

[*Minorus lucigaster* n. sp.]

In size, shape and sculpture of body almost identical with *M. rugiventris* and differing from the latter as follows: — Genæ less prominent. Antennæ slightly more slender, with less dense vestiture, with strongly dilated and transverse ninth and tenth segments, but only slightly transverse eighth segment. Pronotum shaped and sculptured exactly as in *rugiventris*, except for the finer lateral carina. Elytra a little broader, with less distinctly subparallel sides, only minutely demarcated humeral angles, but with the costal arrangement as in *rugiventris*. Legs slightly more slender, the tarsi of identical proportions.

Dimensions. — Length  $7 \frac{1}{2}$  mm, width  $3 \frac{1}{2}$  mm.

Distribution. — Central part of the South-western Cape Province. — Clanwilliam, R. LIGHTFOOT (1 spec., sex not determined, holotype S.A.M.).

47. Clypeal sutures absent, but the lateral portion of epistome demarcated from outlines of genæ by a strong sinuosity. Antennæ rather stout, extending to about middle of pronotum; the ninth and tenth segments strongly transverse, the eighth segment triangular, distinctly broader than long. Elytra with the eighth costa prolonged and almost reaching the apex; tenth costa on reflected lateral portion complete and sharp. Abdominal punctation with long bristles. In the ♂ the underside of posterior femora simple, without subtomentose stripe of yellowish hairs.

[*Minorus jouberti* n. sp.]

(Fig. 213.)

Very opaque, black, the appendages of a dark reddish brown colour. Head above densely rugose and with scattered, conspicuous, yellowish bristles. The contours of genæ, eyes and tempora forming a continuous, subparallel line. Pronotum broadest behind middle, about two-thirds broader than long, very densely and finely rugose, with scattered, very short bristles, rather strong and broad sub-

marginal depression, and with the sides distinctly rounded and narrowed towards posterior angles. Anterior angles produced, base deeply bi-sinuate. Elytra broader than pronotum, weakly rounded and narrowed towards base, the latter without or with only slightly demarcated humeral angles. Costæ fine, primary rows distinct. Punctures on abdomen strong, but well separated, fine and dense on preapical and anal sternites. Legs pubescent, the upper surface of tibiæ flattened, but not sulcate.

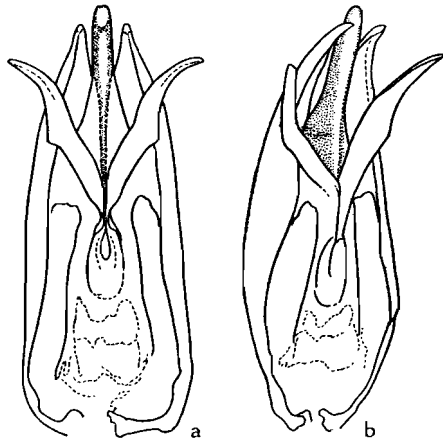

FIG. 213. — Dissected aedeagus of *Minorus jouberti* n. sp.  
a : ventral surface; b : diagonal view.

Remarks. — This species is related to *M. rugiventris* and *lucigaster*, but of larger size, the lateral portions of epistome well separated from the contours of genæ (continuous with the latter in both the compared species), the genæ not prominent, the pronotum more slender, distinctly constricted posteriorly, with a much finer sculpture, and the sides of elytra distinctly narrowed towards base.

Aedeagus (fig. 213). — Large and stout, with the sides converging in a straight line towards apex. Parameres deeply divided, rather strongly gaping for a considerable distance distally, with moderately curved, sharply pointed apices. Ventral groove very broad, leaving exposed penis and lacinia.

Dimensions. — Length  $8\frac{1}{4}$  to  $9\frac{1}{4}$  mm, width 4 to  $4\frac{1}{2}$  mm.

Distribution. — Southern part of the South-western Cape Province. — Stellenbosch, L. PÉRINGUEY (5 spec., types S.A.M.).

Dedication. — Named in honour of Mr. C. J. JOUBERT, principal of the Stellenbosch-Elsenburg College of Agriculture.

- Clypeal sutures sharply and obliquely impressed; the lateral portion of epistome badly demarcated from contours of genæ. Antennæ slender and long, extending almost to base of pronotum; the ninth and tenth segments weakly transverse, the eighth segment slightly longer than broad. Elytra with the eighth costa abbreviated posteriorly and ending at considerable distance from apex; the tenth interval on reflected portion with an extremely fine costula only on median two-thirds; Abdominal punctation with very short, inconspicuous bristles. In the ♂ the underside of posterior femora with a fine, subtomentose stripe of yellowish hairs.

[*Minorus sericeus* n. sp.]

Closely related to *M. jouberti*, but of larger size, the upper surface of body less opaque, head above and pronotum bare, the antennæ much less densely pilose, the pronotum more slender, only one and a half times as broad as long, with substriolate sculpture on disc, broader submarginal depression and posteriorly more strongly narrowed sides. The elytra with more regular and very distinct punctation of primary rows and intervals. Legs long and slender, the upper surface of tibiæ subsulcate.

Dimensions. — Length 10  $\frac{1}{4}$  mm, width 5  $\frac{1}{4}$  mm.

Distribution. — Central part of the South-western Cape Province. — Clanwilliam, VII.1946 (1♂, ex Stellenbosch University, holotype T.M.).

48. Disc of pronotum with extremely dense, sharply rugose sculpture as in all the preceding species of *Minorus*. All dorsal intervals on elytra carinate, the sutural interval included (as in all the preceding species of *Minorus*) ..... 49
- Disc of pronotum with rather scattered, round, separated punctures. On disc of elytra at least the sutural interval flat to convex, but not costate ..... 50
49. Elytral costæ sharply denticulate; the entire outlines of elytra serrate; pseudopleural carina extremely fine; pseudopleura complete, extending to apex. Pronotum, apart from the dense, subreticulate ground sculpture, with numerous, strongly raised, round granules on disc; sides distinctly rounded and narrowed towards base; submarginal depression strong. Abdomen with very dense, subgranular punctures. Antennæ stout, with the exception of the four proximal segments all other segments more or less transverse.

[*Minorus XVIII-seriatus* n. sp.]

On account of the serrate costæ on elytra and the supplementary granules on pronotal disc similar to *M. sculpticeps* and *namaquanus*. In the elytral sculpture, particularly by the sharply serrate-den-

ticulate costæ, almost completely agreeing with *sculpticeps*, but the upper surface of head plane, with only faintly indicated clypeal sutures laterally, the eyes strongly constricted by genal canthus, but not divided, the antennæ much stouter and about twice as broad, the pronotum with the sides distinctly rounded and narrowed towards posterior angles, the submarginal depression strong and well demarcated from disc and the supplementary sculpture on disc consisting of round granules and not of irregularly shaped rugosities, the elytra slightly rounded and narrowed towards base, very similar in sculpture, but the tenth interval on reflected lateral portion plane and not costate. The upper surface of tibiæ sulcate, as in *sculpticeps*.

From *M. namaquanus*, with which *XVIII-seriatus* agrees well in the formation and sculpture of head and pronotum, readily distinguished by the very stout and broad antennæ, the posteriorly rounded and narrowed sides of pronotum and especially by the much more strongly serrate-denticulate costæ, as well as by the plane and not costate tenth interval on the reflected portion of elytra. Both species, however, agree in the plane upper surface of head, the constricted, but not divided eyes and the round supplementary granules on pronotal disc.

Dimensions. — Length  $7 \frac{1}{2}$  mm, width  $3 \frac{3}{4}$  mm.

Distribution. — Eastern part of the North-western Cape Province. — Pofadder, VIII.1950, C. KOCH & G. VAN SON (1 spec., sex not determined, holotype T.M.).

- Elytral costæ smooth as are the outlines of elytra; pseudopleural carina strong; pseudopleura abbreviate posteriorly, with the pseudopleural carina coalescent with the epipleural one at considerable distance from apex. Pronotum with very dense, rugosely confluent ground-sculpture, but without supplementary granules on disc; sides subparallel posteriorly and not narrowed towards base; submarginal depression confined to a fine and narrow canaliculation along sides. Abdomen with rather fine and scattered, round punctures. Antennæ strongly accrescent towards apex, but with only three transverse penultimate segments.

[**Minorus thornei** n. sp.]

Very similar to *M. rugicollis*, but the genal canthus only moderately constricting eyes, not dividing the latter, the antennæ much stouter, with similar proportions of segments, the subparallel course of pronotal sides commencing in front of middle (behind middle in *rugicollis*), and the elytra different. The integument of the latter is less opaque, smoothed and the inner costæ are much finer, with an extremely fine crest on sutural and second intervals; primary

rows sublineate, with very distinct and regular punctation; intervals with extremely fine punctures; on apical declivity the third and seventh costæ coalescent; pseudopleura abbreviated posteriorly (complete in *rugicollis*); the tenth interval on reflected portion of elytra plane and without the sharp costa which is present in *rugicollis*. Upper surface of tibiæ sulcate; the apex of anterior tibiæ only slightly narrower than length of ungual segment of anterior tarsi.

Dimensions. — Length  $7 \frac{3}{4}$  to  $8 \frac{3}{4}$  mm, width  $3 \frac{1}{2}$  to about 4 mm.

Distribution. — Central part of the Southern Cape Province. — George District, VIII.1931, C. THORNE (7 spec., types S.A.M.).

Dedication. — Named in honour of Mr. C. THORNE of the South African Museum.

50. Upper surface of body shiny. Head above, pronotum and abdomen with scattered, short, but distinct hairs. Pronotum broadest behind middle, with the sides subparallel or slightly narrowed towards base. Intervals of elytra with dense, conspicuous punctures, distinctly costate only on outer intervals, with the costæ becoming more or less evanescent on inner intervals; on apical declivity the third costa not in contact with the seventh costa; reflected portion, apart from the punctures of primary rows, densely and irregularly punctured.

[*Minorus pilosicollis* n. sp.]

Greatly differing from all the preceding *Minorus* by the flattened and not costate inner intervals of elytra, the round, well separated punctation on disc of pronotum, and the only slightly constricted eyes. On account of these particulars similar to *Zadenos delalandei*, from which it is easily distinguished by the pilosity on upper surface of head, pronotum and abdomen, the only weakly shiny pronotum, the coarser discal punctures on the latter and less produced anterior angles, the posteriorly briefly depressed prosternal apophysis, the shorter and laterally slightly rounded elytra, as well as by the non-dimorphic legs. The upper surface of head is plane, the epistomal lateral contours not demarcated from the genal ones and the genæ are subparallel. Antennæ stout, with triangular eighth segment and transverse ninth and tenth segments. Pseudopleura abbreviated posteriorly. Abdomen with rather fine, scattered punctures on proximal sternites, very densely punctured on anal sternite. Legs robust, the apex of anterior tibiæ only a little narrower than length of the ungual segment of anterior tarsi; the upper surface of anterior tibiæ edged, that of intermediate tibiæ weakly sulcate.

*Ædeagus*. — Of simple shape and stout; sides of apical portion narrowed towards apex. Parameres gaping, with sharply pointed and bent apices. Ventral groove broad, leaving exposed penis and lacinia; penis broad, subparallel, with almost truncate apex; lacinia much narrower than penis, only slightly shorter, straight, with rounded apices.

*Dimensions*. — Length  $6\frac{3}{4}$  to  $8\frac{1}{4}$  mm, width  $3\frac{3}{4}$  to  $4\frac{1}{2}$  mm.

*Distribution*. — Western and central parts of the Southern Cape Province. — Still Bay, XI.1940, G. VAN SON (17 spec., types T.M.); Mossel Bay, I.1951, P. BRINCK & G. RUDEBECK (U.L.), same locality, IX.1921, R. E. TURNER (B.M.); George District, VIII.1931, C. THORNE (S.A.M.).

- Upper surface of body very opaque. Head above, pronotum and abdomen practically bare, with only microscopically short bristles. Pronotum broadest between posterior angles, with the sides slightly and gradually dilated towards base. Intervals of elytra with scarcely discernible, practically absent punctation; the six outer intervals distinctly costate on disc, the sutural and second intervals there with a row of extremely fine, widely separated granules; on apical declivity the third and seventh costæ coalescent in front of apex; reflected portion smooth, except for the two finely punctured primary rows.

[*Minorus barnardi* n. sp.]

Agreeing with *M. pilosicollis* in the not costate two inner intervals on elytra, the round, separated punctures on disc of pronotum, and the slightly constricted eyes. Readily distinguished from this species by the above mentioned characters, as well as by the stouter and densely pilose antennæ, the broader elytra with apically evanescent second costa (which is sharply raised on apical declivity in *pilosicollis*), and the finer punctation on abdomen and legs. The upper surface of all tibiæ sulcate.

*Dimensions*. — Length  $7\frac{3}{4}$  mm, width  $3\frac{3}{4}$  mm.

*Distribution*. — Central part of the Southern Cape Province. — Seven Weeks Poort, K. H. BARNARD (1 spec., sex not determined, holotype S.A.M.).

*Dedication*. — Named in honour of Dr. K. H. BARNARD, former director to the South African Museum, Cape Town.

- 51. Body small, 4 to  $5\frac{3}{4}$  mm long. Pronotum not cordiform; its sides not sinuate in front of posterior angles, with smooth lateral carina and very narrow, canaliculate submarginal depression. Elytra with smooth lateral contours and costate to plane intervals. Upper surface of tibiæ not sulcate, underside of anterior femora simple, with straight lateral contours.



**LASIODERUS** MULSANT & REY ..... 52

\*1854 *a*, *Lasioderus* MULSANT & REY, p. 186. — 1854 *b*, MULSANT & REY, p. 42. — 1953 *a*, KOCH, pp. 271, 272.

Very similar to *Zadenos* and agreeing with this genus in all principal features, but constantly differing by only nine primary rows on elytra instead of ten; the ventrally reflected portion of elytra not or only very slightly broader than the pseudopleura, and with a single primary row of punctures. Eyes constricted by genal canthus, but not divided, often only weakly emarginated. Pseudopleura abbreviated apically. Shape of body almost subparallel, the size always small.

Type species. — *Lasioderus sulcipennis* MULSANT & REY, 1854.

Distribution (map 5). — Southern Africa. Endemic to a small area of the eastern part of the Central Cape Province, from the Port Elizabeth District northwards into the Southern Orange Free State.

- Body large, about 10 mm long. Pronotum strongly cordiform, its sides deeply sinuate in front of posterior angles, with irregularly crenulate lateral carina and very broad, strong submarginal depression. Elytra with strongly crenulate to obtusely serrate lateral contours and tuberculate intervals. Upper surface of tibiae sulcate, the underside of anterior femora with an arcuate dilation behind middle of lateral contours.

**HADRODERUS** n. gen.

Monotypical.

Type species : —

**Hadroderus tuberculiferus** n. sp.

(Pl. XXXI, fig. 4.)

Shiny; of a very black tint, the antennæ, maxillary palpi and tarsi dark reddish brown; bare. Head as in *Zadenos*. Upper surface plane, densely and rugosely punctured, substriolate on vertex. Epistome with deep median emargination; its lateral contours slightly demarcated from those of genæ. The latter weakly narrowed towards eyes; genal canthus constricting eyes on about anterior half. Eyes without supra-orbital structures, their outlines continuous with those of tempora, but including a widely open angle with genal contours. Labrum emarginate apically: epipharynx with a few long bristles on both sides. Mentum and maxillary palpi as in *Zadenos*. Mandibular portion of postgenal margin produced into a long and sharp tooth. Antennæ as in *Zadenos*, with eleven segments, the

eighth segment triangular and a trifle broader than long, the ninth and tenth segments transverse. Pronotum broadest behind middle, twice as broad as head and almost twice as broad as long, uniformly covered with a very dense, coarse and rugosely confluent punctation. Sides strongly rounded and deeply sinuate in front of posterior angles: the lateral carina strong and widely, irregularly crenulate: submarginal depression broad. Anterior margin strongly carinate laterally, with moderately produced, rather blunt anterior angles. Base marginate, bi-sinuate, with sharply rectangular and distinctly produced posterior angles. Prosternum as in *Zadenos*; with coarse, but scarcely confluent punctures, the flattened submarginal portion of episternum smoothed, the intercoxal apophysis produced horizontally and with demarcated, somewhat tuberculate apex. Elytra broader than pronotum, strongly rounded and narrowed towards base, with prominent, rather large humeral angles. Primary rows very regular and composed of coarse punctures. Intervals with dense, extremely fine and barely perceptible punctures; each interval with a longitudinal row of roundish to elongate tubercles which are coarser and more concentrated on outer intervals; on apical declivity only the third, seventh and eighth intervals subcostate, but the apices of costæ well separated one from another, and, with exception of the eighth costa, not reaching the apex of elytra; the apex of the ninth costa separated from pseudopleural carina. Reflected lateral portion of elytra scarcely broader than pseudopleura, with only a single primary row, running very close to pseudopleural carina and composed of coarse punctures; the ventral portion of ninth interval with very fine, irregular punctation. Pseudopleura abbreviated posteriorly, strongly and irregularly punctured; pseudopleural carina sharp, smooth, bent towards humeral angle basally and coalescent with the epipleural carina at about level of middle of anal sternite. Abdomen as in *Zadenos*; very coarsely but not too densely punctured, with the punctures becoming finer and more scattered on intermediate sternites; anal sternite with extremely dense, very coarse and subfoveate punctures, finer and rugosely confluent near to apical margin. Legs pubescent, very densely, somewhat asperously punctured. The tibiæ stout; the anterior ones rather strongly dilated towards apex, there almost as broad as length of unguis segment of anterior tarsi, with the upper surface sharply edged and subsulcate on distal two-thirds; the upper surface of intermediate and posterior tibiæ subsulcate. Tarsi short, with prolonged unguis segment; in the single known specimen, sex not determined, the anterior tarsi are not dilated, nor exhibit the legs any other distinctive characters, with the exception of the postmedian dilation of lateral contours of underside of anterior femora.

Remarks. — This genus is very well characterized by the reduced number of primary rows on elytra. Not a single of the many species of *Zadenos* and *Minorus* shows any tendency to a reduction in the number of primary rows, but all species exhibit constantly a broad reflected portion of elytra, with two primary rows. For the remainder *Hadroderus* appears to be closely related to *Zadenos*, resembling in particular *Zadenos tuberculatus* on account of the tuberculated elytral intervals and the strongly cordiform pronotum.

Dimensions. — Length 10 mm, width  $4 \frac{3}{4}$  mm.

Distribution (map 5). — Natal. — Ingwawama, Zululand, VII.1938. R. F. LAWRENCE (1 spec., sex not determined, holotype S.A.M.).

52. The discal portion of the inner intervals of elytra distinctly costate, with the exception of the sutural interval which is sometimes obsoletely costate or obtusely convex ..... 53
- At least the discal portion of the sutural and second intervals on elytra plane, without any trace of costæ, but sometimes also the third and fourth intervals only convex and not distinctly costate ..... 54
53. Upper surface of head, pronotum and abdomen with conspicuous, rather long and dense hairs; the elytra densely covered with very short, punctiform, but well perceptible hairs, somewhat appearing as if pulverulent. On apical declivity of elytra the ninth costa coalescent with the pseudopleural carina in front of apex of elytra.

[*Lasioderus sulcipennis* MULSANT & REY.]

\*1854 a, *Lasioderus* MULSANT & REY, p. 186. — 1854 b, MULSANT & REY, p. 42. — REY, p. 43.  
1870, *Eurynotus sulcipennis* GEMMINGER & DE HAROLD, p. 1914. — 1910 b, GEBIEN, p. 276. — 1938-1942, GEBIEN, p. 414, n° 5547.

Original description. — « Long. 6,1 mm, lat. 2,3 mm. — Corps oblong; assez faiblement convexe; brun; visiblement pubescent sur la tête et le prothorax, peu distinctement sur les élytres. Tête réticuleusement ou rugueusement ponctuée; sillonnée sur la suture frontale. Labre et palpes d'un fauve testacé. Antennes prolongées environ jusqu'aux trois cinquièmes ou un peu plus des côtés du prothorax; pubescentes; d'un rouge testacé, graduellement plus claires vers l'extrémité; grossissant graduellement vers celle-ci; le troisième article de moitié à peine plus long que le suivant; les huitième à dixième en ovale transverse; le onzième de moitié plus long que le précédent. Prothorax élargi en ligne courbe d'avant en arrière, d'une manière assez marquée sur le premier tiers, presque parallèle ou peu sensiblement élargi ensuite; en ligne presque droite

à la base ou du moins sur les deux tiers médiaires, à peine sinué à chaque sixième ou septième externe, avec les angles postérieurs très faiblement dirigés en arrière et prononcés; médiocrement convexe, avec les bords latéraux relevés et formant par là une gouttière à leur côté interne; marqué de points assez gros donnant naissance à un poil soyeux assez long. Écusson en triangle plus large que long. Élytres à peu près en ligne droite à la base; offrant à l'angle huméral une très petite dent dirigée en dehors; presque parallèles jusqu'aux trois cinquièmes; en ogive étroite postérieurement; assez faiblement convexes; à neuf sillons; dont huit seulement visibles en dessus : ces sillons, marqués dans le fond d'une rangée longitudinale de points ronds assez gros, séparés entre eux par des espaces lisses, notés de chaque côté d'une rangée de points assez petits. Intervalles étroits, saillants en forme d'arête; garnis près de leur tranche de poils laineux, cendrés, courts, fins, peu apparents; le sutural divergeant en avant pour enclorre, avec son pareil, l'écusson; les troisième et septième postérieurement unis et prolongés après leur réunion jusqu'à l'angle sutural; le septième, aboutissant en avant à l'angle huméral, en se courbant en dehors; les troisième et septième postérieurement unis en enclosant les quatrième à sixième; le cinquième plus long que les deux autres. Repli assez grossièrement ponctué. Dessous du corps parcimonieusement pubescent; d'un rouge-brun ou d'un brun-rouge; marqué d'assez gros points, moins gros sur le ventre que sur les côtés de l'antépectus. Prosternum ponctué, peu distinctement rebordé. Pieds d'un fauve testacé; pubescents; tibias antérieurs un peu élargis; plans et râpeux en dessous. »

Remarks. — Lateral portion of epistome not separated from genal contours. Genæ short, practically subparallel in front of eyes. The latter faintly projecting, with their lateral outlines almost continuous with those of genæ, moderately constricted by the genal canthus anteriorly. Antennæ stout and short, strongly accrescent towards apex, with four transverse penultimate segments and large apical segment. Pronotum broadest at about middle, almost twice as broad as long, densely covered with coarse and setiferous punctures, round but very dense on disc, becoming slightly rugose on lateral portions. Submarginal depression weak, dilated towards base. Anterior margin shallowly emarginated, with only faintly produced anterior angles. Base from straight to very weakly bi-sinuate, carinate only on lateral portions, with rectangular, but not produced posterior angles. Elytra subparallel, very little broader than pronotum, with fine and minutely prominent humeral angles. Primary rows with strong and regular punctures; intervals scarcely punctured, appearing as if smooth, less shiny than the remaining

upper surface, sharply costate, except for the sutural interval which sometimes is obtusely tectiform; costal arrangement as indicated in the original description, with apically prolonged and coalescent third and seventh costæ. Pseudopleura abbreviate posteriorly, rather coarsely punctured. Abdomen uniformly covered with a rather strong, moderately dense punctation which is scarcely denser on the anal sternite than on proximal sternites. Legs pilose and stout; the upper surface of tibiæ shiny, but rather densely punctured, that of anterior tibiæ obtusely edged, that of intermediate and posterior tibiæ simple and not sulcate; the anterior tibiæ moderately dilated towards apex, the latter distinctly narrower than length of ungual segment of anterior tarsi. Tarsi stout, with short proximal segments and strongly prolonged ungual segment. ♂ unknown.

Dimensions. — Length 5 to 6 mm, width  $2 \frac{1}{4}$  to  $2 \frac{1}{2}$  mm.

Type locality. — « Cap de Bonne-Espérance ». Type probably in Museum Paris (coll. CHEVROLAT).

Distribution. — Central part of the Southern Cape Province. — Addo Bush, VII.1919, J. DRURY (1♀, S.A.M.). A further ♀ from the Cape Province, without specified locality, in T.M.

- Upper surface of head, pronotum and abdomen with very short, inconspicuous hairs; the elytra practically bare, as the hairs are microscopically short and scarcely discernible. On apical declivity of elytra the ninth costa not in contact with the pseudopleural carina.

[*Lasioderus vanhillei* n. sp.]

(Figs. 214, 215.)

Very closely related to *L. sulcipennis*, but the pilosity on body not conspicuous, the upper surface more strongly shiny, the antennæ slightly more slender, but with similar proportions of segments, the pronotum a trifle narrower, less densely punctured, with the sides not exactly subparallel and straight as is the case in *sulcipennis*, but very slightly rounded and narrowed towards base, with very thick lateral carina, but only canaliculate submarginal depression. The elytra as in *sulcipennis*, but the costæ more strongly raised, sharper, and the ninth costa separated from the pseudopleural carina apically. Abdomen with finer and more scattered punctures. In the ♂ legs with remarkable, distinctive characters; the anterior tarsi strongly dilated, with transverse second, third and fourth segments; the anterior tibiæ (fig. 214) straight, but the inner contours exhibiting a strong, obtusely dentiform median dilation which bears some squarrose short bristles; the intermediate tibiæ almost straight, rather thick, as the anterior tibiæ with convex,

shiny, rather sparsely punctured upper surface, but with a fine fringe of hairs on distal half of underside; the posterior tibiae with shiny, convex, sparsely punctured upper surface, slightly curved and with a dense fringe of hairs on underside; the femora sparsely punctured, the underside of intermediate and posterior ones with a subtomentose proximal stripe of fine, yellowish hairs.

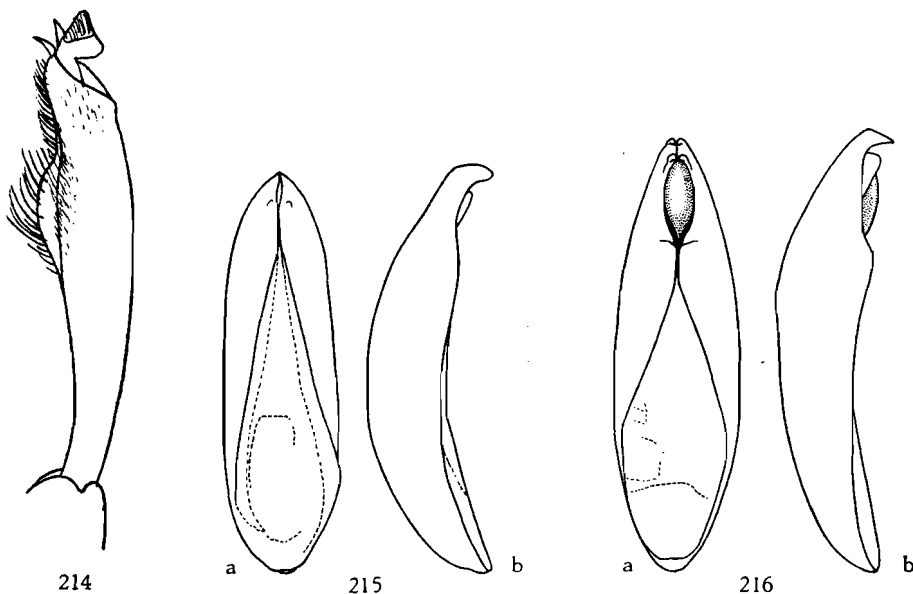

FIG. 214. — Anterior tibia of a ♂ of *Lasioderus vanhillei* n. sp.

FIG. 215. — Aedeagus of *Lasioderus vanhillei* n. sp.

FIG. 216. — Aedeagus of *Lasioderus dicksonæ* n. sp.

a : ventral surface; b : lateral view, with the ventral surface at right.

**Aedeagus** (fig. 215). — Broad and rather strongly complanate. The apical portion of tegmen slightly narrowed in a straight line, but the apex itself triangularly pointed. Parameres deeply divided, but closely attached to one another, with straight and converging apices. Ventral groove entirely closed by the extremely dilated, flat inflexed alæ concealing the inner sclerite.

**Dimensions.** — Length 5 to 5  $\frac{1}{4}$  mm, width about 2  $\frac{1}{4}$  mm.

**Distribution.** — Central part of the Southern Cape Province. — Grahamstown, II.1933, R. F. LAWRENCE (2 ♂♂, holotype S.A.M.).

**Dedication.** — Named in honour of Dr. J. C. VAN HILLE, Zoological Department of Rhodes University.

54. Body brownish. Sides of pronotum slightly to distinctly narrowed to posterior angles. On apical declivity of elytra the third costa prolonged, angularly bent towards suture in front of apex and coalescent with the latter apically ..... 55
- Body very black. Sides of pronotum straight and subparallel on posterior two-thirds. On apical declivity of elytra the third costa straight, subparallel with suture and not reaching the apex.

[*Lasioderus dicksonæ* n. sp.]

(Fig. 216.)

Related to *L. vanhillei*, from which it is easily distinguished as follows : — Body smaller and broader, the upper surface black and shiny as in *vanhillei*, but the hairs on pronotum still shorter and more scattered, scarcely perceptible. Head as in *vanhillei*; the antennæ shorter, with the third segment only a trifle longer than the second segment or of almost equal length. Pronotum of very similar shape and identical, coarse, well separated punctation; the sides exactly parallel posteriorly and without any submarginal depression, but distinctly impressed transversely on each side of base. Elytra practically subparallel, but faintly dilated posteriorly, more convex, strongly shiny, with microscopically short, punctiform hairs. Humeral angles rectangular, not prominent. Primary rows a little finer; intervals distinctly and rather densely punctured (appearing as if smooth in *vanhillei*); the outer intervals sharply costate, the inner ones with fine costæ, becoming finer towards suture and subgranulate on apical declivity, the sutural and second intervals convex and not costate at least on disc; apex of third costa abbreviate, not reaching the elytral apex, nor approximated to suture, but coalescent with the seventh costa. In the ♂ the anterior tarsi distinctly dilated and soleate below; the anterior tibiæ with excavate underside, the inner contours rather strongly dilated towards middle and slightly emarginate on distal third; the inner contours of intermediate and posterior tibiæ with fringe of short, dense hairs distally.

Ædeagus (fig. 216). — Similar to *L. vanhillei*, but the tegmen less strongly complanate, the sides of apical portion narrowed in a straight line to the extreme and not triangularly demarcated apex, and the ventral groove open, leaving exposed the apical portion of penis.

Dimensions. — Length 4 to 4  $\frac{3}{4}$  mm, width 2  $\frac{1}{4}$  mm.

Distribution. — Central part of the Southern Cape Province. — Port Elizabeth, Mrs. K. M. DICKSON (2 ♂, 1 ♀, types T.M.).

Dedication. — Named in honour of the discoverer, Mrs. K. M. DICKSON, Durban.

55. Pronotum very slightly narrowed towards posterior angles, with dense, confluent punctures on middle of disc and longitudinally rugose to substriolate on lateral portions; the anterior margin shallowly emarginate, with straight median portion of emargination and the anterior angles distinctly produced beyond level of the latter. Elytra subparallel, not constricted basally; the third, fourth and fifth costæ very fine, with distinctly crenulate to subgranulate crest.

[*Lasioderus kannemeyeri* n. sp.]

Very similar to *L. dicksonæ* and agreeing with the latter in the discally incostate sutural and second intervals on elytra. Narrower than *dicksonæ*, of a dark brownish colour, the appendages paler, the head with denser and subrugose sculpture, the antennæ a little finer, the pronotum bare, much more densely and rugosely punctured, the anterior emargination more shallow and the sides not subparallel posteriorly. The elytra very similar, but exactly subparallel and not dilated posteriorly, the humeral angle minutely but sharply projecting. The costal arrangement, as well as the sculpture of primary rows and secondary intervals much resembling these structures in *dicksonæ*; on apical declivity the apex of the seventh costa well separated from the third costa. Pseudopleura irregularly punctured. Abdomen with dense and rather strong punctation, concentrated on anal sternite. In the ♂ the anterior tarsi moderately dilated, small, with strongly transverse second, third and fourth segments; all tibiæ and femora without distinctive characters, except for the underside of anterior tibiæ, which is smoothed, slightly depressed and shiny on middle portion.

Dimensions. — Length 5 ½ mm, width 2 ½ mm.

Distribution. — Southern part of the Orange Free State. — Smithfield, 1908, KANNEMEYER (1 ♂, holotype S.A.M.).

Dedication. — Named in memory of the late Dr. KANNEMEYER of Smithfield.

- Pronotum rather strongly rounded and narrowed towards posterior angles, with round, well separated, coarse punctures on disc, becoming only faintly confluent on lateral portions; the anterior margin bi-sinuate, as the median portion is weakly and broadly produced and the anterior angles not projecting beyond level of the latter. Elytra distinctly rounded and narrowed towards humeral angles; the third, fourth and fifth costæ rather broad and obtuse, with smooth crest.



**[*Lasioderus lænoides* n. sp.]**

Closely related to *L. kannemeyeri* but well characterized among all *Lasioderus* by the basally constricted sides of pronotum and elytra. Apart from the above mentioned characters differing from *kannemeyeri* by the smaller size of body, the paler, reddish brown colour, the shorter antennæ, the less transverse, differently shaped and sculptured pronotum, the somewhat sericeous elytra, the cuticle of which exhibits a very fine micro-reticulation, and finally by the coarser punctures on abdomen. The costal arrangement on elytra is very similar to that in *kannemeyeri*, but the apex of the seventh costa is generally in contact with the apex of third costa. ♂ unknown.

Dimensions. — Length  $4 \frac{3}{4}$  mm, width  $2 \frac{1}{4}$  mm.

Distribution. — Southern part of the Orange Free State. — Colesberg, X.1935, Mus. Staff (2 ♀ ♀, holotype S.A.M.).

56. Genal canthus broadly rounded and narrowed towards eyes, only moderately projecting beyond the latter and faintly constricting them anteriorly. Pronotum loosely attached to elytra, considerably narrower than the latter; base with strongly produced middle portion which projects backwards beyond level of posterior angles, and with two short, but deep lateral sinuosities which leave exposed an angular portion of the prosternal episterna, formed by a sharp, oblique carinula which runs from the basal margination of prothoracic foramen towards posterior angles of pronotum. Elytra shiny, with ten regularly punctured primary rows and all intervals provided with minutely serrate costæ; in ventral aspect the reflected portion of elytra much broader than pseudopleura, with two primary rows and costate tenth interval.

**PSEUDEMMALLUS** n. gen.

Monotypical.

Type species : —

***Pseudemmallus aspericollis*** n. sp.

Body apterous, elongate, shiny, black, with reddish brown appendages. Head as in *Zadenos*, but the labrum with strongly raised carina on the subtruncate apical margin. Upper surface with very coarse, subrugose punctures, from which arise short, erect bristles, concentrated on supra-orbital portion. Lateral contours of epistome

indistinctly separated from genæ. Frons separated from vertex by a shallow, transverse epistomal impression. Antennæ short, stout, setiferous, only a little longer than width of head; the fifth and sixth segments about square or slightly broader than long, the four penultimate segments transverse; apical segment small and roundish, much narrower and a little shorter than the preceding segment. Pronotum rather slender, broadest at about middle and not quite one and a half times as broad as long, with the sides equally rounded and narrowed towards anterior margin as well as towards base. Integument peculiar, uniformly covered with very dense, coarse, rugose punctures, the anterior margin of which is strongly raised, forming dense, lunulate, asperate rugosities; these punctures bear short, yellowish bristles. Submarginal depression of sides canaliculate, with smooth and shiny background of cuticle, sharply separating the lateral margin from the rather strong discal convexity; lateral carina extremely fine, almost obsolescent, punctured and therefore appearing as if minutely serrate or crenulate, with short yellowish cilia, arising from punctures. Anterior margin shallowly bi-sinuate, similar to *Lasioderus lænoides*, with the short anterior angles not produced beyond level of middle portion. The peculiar formation of the immarginate base as described above. Prosternum, together with episternum, with rather scattered, round, very coarse, subfoveate, setiferous punctures; intercoxal apophysis obliquely depressed, with subtuberculate apex. Elytra oblong, broader than pronotum, with the sides distinctly rounded and narrowed towards base, as is the case in *Lasioderus lænoides*. Humeral angles not prominent. Sculpture similar to *Lasioderus* or many *Zadenos*; primary rows with coarse, round and regular punctures; all intervals smooth, sharply costate, with the crest of costæ minutely serrate or crenulate, bearing a row of short, semi-erect, yellowish bristles; the costa of sutural interval evanescent between base and apical declivity; on the latter all costæ abbreviate, except for the eighth costa which runs around apex parallel with the pseudopleural carina and coalesces with the prolonged second costa. The lateral outlines in part minutely serrate, particularly on basal and apical portions. Pseudopleura complete from base to apex, with the obsoletely crenulate pseudopleural carina bent towards humeral angle basally. Metasternum short, about half the length of basal sternite of abdomen and between meso and metacoxal cavities a little shorter than longitudinal diameter of the latter. Abdomen setiferous, the proximal sternites with dense, coarse punctures, the two penultimate sternites with scattered and very fine punctation. (Anal sternite missing). Legs as in *Lasioderus*, short and pilose; the anterior tibiæ rather strongly dilated towards apex, there almost broader than

length of unguis segment of anterior tarsi, with edged and spinose upper surface and asperously granular outer lateral surface; tarsi with bristles below, the unguis segment produced.

Remarks. — This genus, which is well characterized by the peculiar formation of pronotal base, resembles *Lasioderus lænoides* on account of the basally constricted pronotum and elytra, but exhibits ten primary rows, of which two are situated on the reflected lateral portion of elytra, the same as in *Zadenos*.

Dimensions. — Length  $5 \frac{1}{4}$  mm, width  $2 \frac{1}{4}$  mm.

Distribution (map 5). — Northern Transvaal. — Salt Pan, Zoutpansberg District, VII.1949, C. KOCH & G. VAN SON (1 spec., sex not determined, holotype T.M.).

- Genal canthus rectangular, very strongly narrowed towards, and strongly projecting outwards beyond, eyes, strongly constricting the latter on anterior two-thirds. Pronotum closely jointed to elytra, broader than elytra or of equal width; base deeply bi-sinuate, but the posterior angles, as usual, produced backwards, at least reaching the level of middle portion of base and not leaving exposed any portion of underside of prothorax; formation of basal margination of prothoracic foramen simple, without supplementary carinula on lateral portion of episternum of prosternum. Elytra dull to moderately shiny, either with nine regularly punctured primary rows, but non-costate intervals, or with scarcely defined primary rows, but subcostate alternating odd intervals; in ventral aspect the entire reflected portion of elytra occupied by the pseudopleura, the outer portion of elytra lateral in position, not or obsoletely visible in ventral aspect ..... 57
57. Body apterous; densely covered with sessile, elongate yellowish scales; small, only  $5 \frac{1}{4}$  to  $5 \frac{1}{2}$  mm long. Pronotum broadest in front of middle and there distinctly broader than elytra; very closely fitting to elytral base, with the lateral contours together with those of elytra forming a continuous line. Elytra short, not quite twice as long as pronotum, strongly narrowed in a straight line on posterior half, with regular primary rows and flat to convex, but not costate secondary intervals. Annal sternite immarginate.